

# TASCAM

D01155420E

# SS-CDR200

Solid State/CD Stereo Audio Recorder

# SS-R200

# SS-R100

Solid State Stereo Audio Recorder

## OWNER'S MANUAL

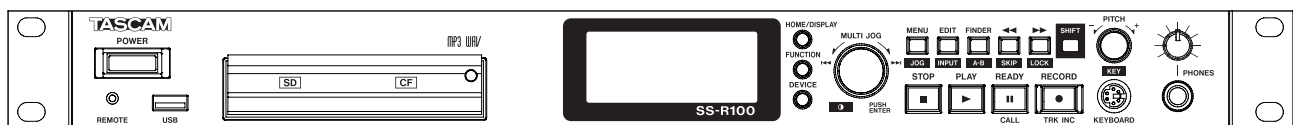

# IMPORTANT SAFETY PRECAUTIONS



**CAUTION**  
RISK OF ELECTRIC SHOCK  
DO NOT OPEN



**CAUTION:** TO REDUCE THE RISK OF ELECTRIC SHOCK, DO NOT REMOVE COVER (OR BACK). NO USER-SERVICEABLE PARTS INSIDE. REFER SERVICING TO QUALIFIED SERVICE PERSONNEL.



The lightning flash with arrowhead symbol, within equilateral triangle, is intended to alert the user to the presence of uninsulated "dangerous voltage" within the product's enclosure that may be of sufficient magnitude to constitute a risk of electric shock to persons.



The exclamation point within an equilateral triangle is intended to alert the user to the presence of important operating and maintenance (servicing) instructions in the literature accompanying the appliance.

**WARNING: TO PREVENT FIRE OR SHOCK HAZARD, DO NOT EXPOSE THIS APPLIANCE TO RAIN OR MOISTURE.**

For U.S.A.

TO THE USER

This equipment has been tested and found to comply with the limits for a Class A digital device, pursuant to Part 15 of the FCC Rules. These limits are designed to provide reasonable protection against harmful interference when the equipment is operated in a commercial environment. This equipment generates, uses, and can radiate radio frequency energy and, if not installed and used in accordance with the instruction manual, may cause harmful interference to radio communications. Operation of this equipment in a residential area is likely to cause harmful interference in which case the user will be required to correct the interference at his own expense.

#### CAUTION

Changes or modifications to this equipment not expressly approved by TEAC CORPORATION for compliance could void the user's authority to operate this equipment.

In North America use only on 120V supply.

#### For Canada

THIS CLASS A DIGITAL APPARATUS COMPLIES WITH CANADIAN ICES-003.CET  
APPAREIL NUMERIQUE DE LA CLASSE A EST CONFORME A LA NORME NMB-003 DU CANADA.

## ■ For European Customers

### WARNING

This is a Class A product. In a domestic environment, this product may cause radio interference in which case the user may be required to take adequate measures

### Disposal of electrical and electronic equipment

- All electrical and electronic equipment should be disposed of separately from the municipal waste stream via collection facilities designated by the government or local authorities.
- By disposing of electrical and electronic equipment correctly, you will help save valuable resources and prevent any potential negative effects on human health and the environment.
- Improper disposal of waste electrical and electronic equipment can have serious effects on the environment and human health because of the presence of hazardous substances in the equipment.
- The Waste Electrical and Electronic Equipment (WEEE) symbol, which shows a wheeled bin that has been crossed out, indicates that electrical and electronic equipment must be collected and disposed of separately from household waste. 
- Return and collection systems are available to end users. For more detailed information about the disposal of old electrical and electronic equipment, please contact your city office, waste disposal service or the shop where you purchased the equipment.

### CE Marking Information

- Applicable electromagnetic environment: E4
- The average half-cycle r.m.s. inrush current
  - On initial switch-on: 5 Arms
  - After a supply interruption of 5s: 3.6 Arms

### DECLARATION OF CONFORMITY

We, TEAC EUROPE GmbH, Bahnstrasse 12, 65205 Wiesbaden-Erbenheim, Germany declare in own responsibility, the TEAC product described in this manual is in compliance with the corresponding technical standards.



This appliance has a serial number located on the rear panel. Please record the model number and serial number and retain them for your records.

Model number \_\_\_\_\_

Serial number \_\_\_\_\_

# IMPORTANT SAFETY INSTRUCTIONS

- 1 Read these instructions.
  - 2 Keep these instructions.
  - 3 Heed all warnings.
  - 4 Follow all instructions.
  - 5 Do not use this apparatus near water.
  - 6 Clean only with dry cloth.
  - 7 Do not block any ventilation openings. Install in accordance with the manufacturer's instructions.
  - 8 Do not install near any heat sources such as radiators, heat registers, stoves, or other apparatus (including amplifiers) that produce heat.
  - 9 Do not defeat the safety purpose of the polarized or grounding-type plug. A polarized plug has two blades with one wider than the other. A grounding type plug has two blades and a third grounding prong. The wide blade or the third prong are provided for your safety. If the provided plug does not fit into your outlet, consult an electrician for replacement of the obsolete outlet.
  - 10 Protect the power cord from being walked on or pinched particularly at plugs, convenience receptacles, and the point where they exit from the apparatus.
  - 11 Only use attachments/accessories specified by the manufacturer.
  - 12 Use only with the cart, stand, tripod, bracket, or table specified by the manufacturer, or sold with the apparatus. When a cart is used, use caution when moving the cart/apparatus combination to avoid injury from tip-over.
- Do not expose this apparatus to drips or splashes.
  - Do not place any objects filled with liquids, such as vases, on the apparatus.
  - Do not install this apparatus in a confined space such as a book case or similar unit.
  - The apparatus draws nominal non-operating power from the AC outlet with its POWER or STANDBY/ON switch not in the ON position.
  - The apparatus should be located close enough to the AC outlet so that you can easily grasp the power cord plug at any time.
  - The mains plug is used as the disconnect device, the disconnect device shall remain readily operable.
  - Products with Class I construction are equipped with a power supply cord that has a grounding plug. The cord of such a product must be plugged into an AC outlet that has a protective grounding connection.
  - If the product uses batteries (including a battery pack or installed batteries), they should not be exposed to sunshine, fire or excessive heat.
  - CAUTION for products that use replaceable lithium batteries: there is danger of explosion if a battery is replaced with an incorrect type of battery. Replace only with the same or equivalent type.
  - Caution should be taken when using earphones or headphones with the product because excessive sound pressure (volume) from earphones or headphones can cause hearing loss.



- 13 Unplug this apparatus during lightning storms or when unused for long periods of time.
- 14 Refer all servicing to qualified service personnel. Servicing is required when the apparatus has been damaged in any way, such as power-supply cord or plug is damaged, liquid has been spilled or objects have fallen into the apparatus, the apparatus has been exposed to rain or moisture, does not operate normally, or has been dropped.

# Safety Information

## ■ Notes on Laser Product (SS-CDR200)

This product has been designed and manufactured according to FDA regulations "title 21, CFR, chapter 1, subchapter J, based on the Radiation Control for Health and Safety Act of 1968", and is classified as a class 1 laser product. There is no hazardous invisible laser radiation during operation because invisible laser radiation emitted inside of this product is completely confined in the protective housings.

The label required in this regulation is shown at ①.

①

For USA

### CERTIFICATION

THIS PRODUCT COMPLIES WITH 21 CFR 1040.10 AND 1040.11 EXCEPT FOR DEVIATIONS PURSUANT TO LASER NOTICE NO.50, DATED JUNE 24, 2007.

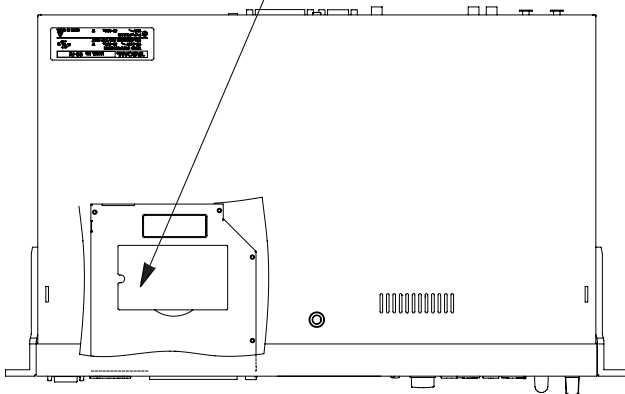

### CAUTION

- DO NOT REMOVE THE PROTECTIVE HOUSING USING A SCREWDRIVER.
- USE OF CONTROLS OR ADJUSTMENTS OR PERFORMANCE OF PROCEDURES OTHER THAN THOSE SPECIFIED HEREIN MAY RESULT IN HAZARDOUS RADIATION EXPOSURE.
- IF THIS PRODUCT DEVELOPS TROUBLE, CONTACT YOUR NEAREST QUALIFIED SERVICE PERSONNEL, AND DO NOT USE THE PRODUCT IN ITS DAMAGED STATE.
- CLASS 1M INVISIBLE LASER RADIATION WHEN OPEN AND INTERLOCKS DEFEATED. DO NOT VIEW DIRECTLY WITH OPTICAL INSTRUMENTS.

### Optical pickup

Type: LO-DWU01  
Manufacturer: Lite-Space Technology Co., Ltd.  
Laser output: Less than 93.1 mW on the objective lens (CD)  
Less than 90.3 mW on the objective lens (DVD)  
Wavelength: 785 nm (CD) typ.  
661 nm (DVD) typ.  
Standard: IEC60825-1: 2007

### Optical pickup

Type: HOP-6201TC  
Manufacturer: Hitachi Media Electronics Co.,Ltd.  
Laser output: Less than 75 mW on the objective lens (record)  
Wavelength: 777 to 787 nm  
Standard: IEC60825-1: 2007

## ■ Rack-Mounting the Unit

Use the supplied rack-mounting kit to mount the unit in a standard 19-inch rack, as shown below.

Remove the feet of the unit before mounting.

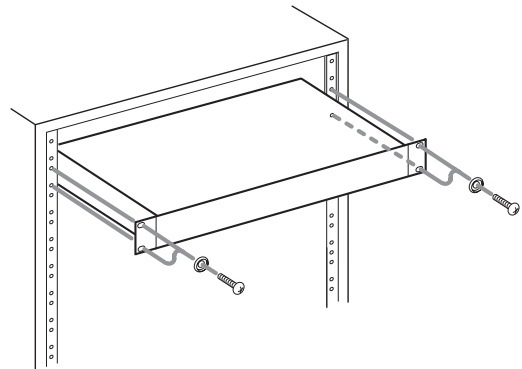

### NOTE

- Leave 1U of space above the unit for ventilation.
- Allow at least 10 cm (4 in) at the rear of the unit for ventilation.

## ■ For China



“仅适用于海拔 2000m 以下地区安全使用”



“仅适用于非热带气候条件下安全使用”



“环境保护使用年限”

### SS-CDR200

产品有毒有害物质或元素的名称及含量

机种：SS-CDR200		有毒有害物质或元素					
	品名	铅 (Pb)	汞 (Hg)	镉 (Cd)	六价铬 (Cr(VI))	多溴联苯 (PBB)	多溴二苯醚 (PBDE)
1	CHASSIS部份	○	○	○	○	○	○
2	CDRW DRIVE部份	×	○	○	○	○	○
3	PCB Assy部份	×	○	○	○	○	○
4	线材部份	○	○	○	○	○	○
5	附属品部份	×	○	○	○	○	○
6	电源部份	×	○	○	○	○	○
7	LABEL部份	○	○	○	○	○	○
8	包装部份	○	○	○	○	○	○

○：表示该有毒有害物质在该部件所有均质材料中的含量均在 SJ/T11363-2006 标准规定的限量要求以下。

×：表示该有毒有害物质至少在该部件的某一均质材料中的含量超出 SJ/T11363-2006 标准规定的限量要求。

(针对现在代替技术困难的电子部品及合金中的铅)

### SS-R200/SS-R11

产品有毒有害物质或元素的名称及含量

机种：SS-R200/SS-R100		有毒有害物质或元素					
	品名	铅 (Pb)	汞 (Hg)	镉 (Cd)	六价铬 (Cr(VI))	多溴联苯 (PBB)	多溴二苯醚 (PBDE)
1	CHASSIS部份	○	○	○	○	○	○
2	PCB Assy部份	×	○	○	○	○	○
3	线材部份	○	○	○	○	○	○
4	附属品部份	×	○	○	○	○	○
5	电源部份	×	○	○	○	○	○
6	LABEL部份	○	○	○	○	○	○
7	包装部份	○	○	○	○	○	○

○：表示该有毒有害物质在该部件所有均质材料中的含量均在 SJ/T11363-2006 标准规定的限量要求以下。

×：表示该有毒有害物质至少在该部件的某一均质材料中的含量超出 SJ/T11363-2006 标准规定的限量要求。

(针对现在代替技术困难的电子部品及合金中的铅)

# Contents

<b>1 – Introduction .....</b>	<b>8</b>		
SS-CDR200, SS-R200 and SS-R100 differences .....	8		
Features .....	8		
Included items .....	8		
Conventions used in this manual.....	8		
Intellectual property rights .....	9		
Precautions for placement and use.....	9		
Connecting the power .....	10		
Beware of condensation.....	10		
Cleaning the unit.....	10		
About USB memory, SD cards and CF cards.....	10		
Precautions for use .....	10		
Media that has been confirmed for use with this unit.....	10		
SD card write-protection.....	10		
Media formatting .....	10		
About compact discs.....	10		
Handling of compact discs .....	10		
About CD-R and CD-RW discs.....	11		
Slot loading of discs .....	11		
User registration .....	11		
<b>2 – Names and functions of parts .....</b>	<b>12</b>		
Front panel .....	12		
Rear panel.....	15		
TASCAM RC-SS2 wired remote control.....	16		
Home Screen .....	17		
Home Screen FUNCTION status display.....	18		
Recording Screen .....	19		
Recording Screen FUNCTION status display .....	19		
Menu structure .....	20		
Menu operation basics.....	21		
Menu operation procedures .....	21		
<b>3 – Preparations.....</b>	<b>23</b>		
Making connections .....	23		
Turning the power ON/OFF .....	24		
Setting the date and time .....	24		
Adjusting the display.....	24		
Adjusting the display contrast .....	24		
Adjusting the display and indicator brightness.....	25		
Inserting and ejecting SD and CF cards.....	25		
Inserting SD and CF cards .....	25		
Ejecting SD and CF cards.....	25		
Using the security screw.....	26		
SD card write protection .....	26		
Inserting and removing discs (SS-CDR200 only) .....	26		
Inserting discs .....	26		
Ejecting discs .....	26		
Selecting the device used.....	26		
Preparing USB/SD/CF media for use .....	27		
Panel lock function .....	27		
<b>4 – Playback .....</b>	<b>28</b>		
Files that can be played .....	28		
Tracks and files .....	28		
Play area .....	28		
Setting the play area.....	28		
Selecting the current folder or current playlist .....	29		
Playback modes .....	29		
Setting the playback mode .....	29		
Basic playback operations .....	29		
Playback .....	29		
Selecting tracks.....	30		
Skipping to the previous or next track.....	30		
Specifying a track number .....	30		
Searching backward and forward .....	30		
Time search .....	30		
Time searching after partial entry.....	30		
Jog playback .....	31		
Skipping backward and forward .....	31		
Setting the skip time.....	31		
Call function .....	31		
Program playback .....	32		
Preparing the program .....	32		
Pitch control playback .....	32		
Setting the pitch step .....	33		
Key control playback .....	33		
Repeat playback .....	33		
Ordinary repeat playback .....	33		
A-B repeat playback .....	34		
Auto Cue function .....	34		
Auto Ready function .....	35		
Incremental playback function .....	35		
Mono playback .....	36		
EOM functions (SS-CDR200/SS-R200 only).....	36		
Setting EOM tally output triggers .....	36		
Example of use.....	37		
Resume playback .....	37		
Using power-on play .....	37		
Link playback function .....	38		
Link playback connections .....	38		
Setting link playback.....	38		
Flash start function .....	38		
<b>5 – Recording .....</b>	<b>40</b>		
Automatic protection against unintentional power interruptions.....	40		
Selecting the input source .....	40		
Selecting the source from the front panel.....	40		
Selecting the source from the remote control .....	40		
Show the input source .....	40		
Setting the recording file format .....	41		
Using the sampling rate converter .....	41		
Monitoring the input signal.....	42		
Adjusting the input signal level and balance .....	42		
Basic recording operations .....	42		
Finalizing CD-R/CD-RW discs (SS-CDR200 only) .....	43		
Finalizing discs .....	43		
Sync recording .....	43		
Sync settings.....	43		

Sync recording operation .....	44
Auto Track function .....	45
Creating a new track manually .....	46
Setting the pause mode .....	46
Using the compressor when recording .....	47
Setting the format for naming recorded files (MP3/WAV files only) .....	47
Inputting and editing characters .....	48
Recording with dither .....	48
Media capacities and recording times .....	49
<b>6 – File and folder operations (FINDER screen) .....</b>	<b>50</b>
Opening the FINDER screen.....	50
Navigating the FINDER screen .....	50
Icons on the FINDER screen.....	50
File operations.....	51
Folder operations.....	51
Editing folder names (USB/SD/CF media only) .....	52
Editing file names (USB/SD/CF media only) .....	52
Deleting folders and files (USB/SD/CF media only).....	53
Adding entire folders to a playlist (USB/SD/CF media only).....	53
Adding files to a playlist (USB/SD/CF media only) .....	53
Creating a new folder (USB/SD/CF media only).....	54
Moving and copying files (USB/SD/CF media only).....	54
Moving a file within a folder .....	54
Move/copy files between folders.....	55
<b>7 – Audio CD FINDER screen (SS-CDR200 only).....</b>	<b>56</b>
Opening the audio CD FINDER screen .....	56
Selecting a track to play .....	56
Editing CD-Text (CD-R/CD-RW disc only).....	56
<b>8 – Using the EDIT menu (USB/SD/CF media only).....</b>	<b>57</b>
Using the edit menu .....	57
Deleting files.....	57
Dividing files.....	57
Combining files.....	58
Undoing EDIT menu operations.....	59
<b>9 – Editing the playlist (USB/SD/CF media only).....</b>	<b>60</b>
Overview .....	60
Open the USER PLAYLIST screen .....	60
Navigating the playlist screen .....	60
Using the playlist FINDER MENU .....	61
Adding files to playlists .....	61
Removing files from playlists .....	62
Moving a file in a playlist .....	62
<b>10 – Copying files between CDs and other media (SS-CDR200) .....</b>	<b>63</b>
Copy/convert and copy files from USB/SD/CF media to blank CDs.....	63
Creating audio CDs.....	63
Creating data CDs .....	65
Converting CD files and copying them to USB/SD/CF media .....	66
Converting and copying audio CD tracks .....	66
Copying files on a data CD.....	67
<b>11 – CD-RW management (SS-CDR200 only).....</b>	<b>69</b>
Unfinalizing CD-RW discs.....	69
Erasing CD-RW discs .....	69
Erasing tracks.....	70
Refreshing discs .....	70
<b>12 – Other settings and media information .....</b>	<b>71</b>
Footswitch control .....	71
Setting up a footswitch .....	71
Using the footswitch .....	71
Footswitch mode functions .....	71
Setting the digital output format.....	71
Setting the analog output attenuation function .....	72
Viewing information about the media .....	72
Restoring the factory settings .....	72
Checking the firmware versions used by the unit .....	73
<b>13 – Operation using a computer keyboard .....</b>	<b>74</b>
Setting the keyboard language .....	74
Using a keyboard to input text .....	74
Keyboard operation list .....	74
<b>14 – Using control I/O (SS-CDR200/SS-R200 only).....</b>	<b>76</b>
Using the RS-232C connector .....	76
Using the parallel connector.....	76
<b>15 – Message list .....</b>	<b>78</b>
Error messages.....	78
Warning messages .....	78
Operation messages .....	79
<b>16 – Troubleshooting .....</b>	<b>80</b>
<b>17 – Specifications .....</b>	<b>81</b>
Media and file formats .....	81
Inputs and outputs .....	81
Analog audio inputs and outputs .....	81
Digital audio inputs and outputs .....	81
Control inputs and outputs .....	81
Audio performance .....	81
Backup memory .....	82
General.....	82
Dimensional drawings .....	83

# 1 – Introduction

Thank you very much for purchasing a TASCAM SS-CDR200 Solid State/CD Stereo Audio Recorder or SS-R200/SS-R100 Solid State Stereo Audio Recorder. Please read this manual thoroughly before using the unit so that you understand correct operating procedures and can use its functions fully. We hope that you enjoy using this unit for many years.

Please keep this manual so that you can read it at any time. A digital copy of this manual can also be downloaded from the TEAC Global Site (<http://teac-global.com/>).

---

## SS-CDR200, SS-R200 and SS-R100 differences

---

The SS-R200 model adds XLR balanced inputs and outputs, serial and parallel control connectors and EOM functions to the features of the SS-R100.

The SS-CDR200 model adds a CD drive to the features of the SS-R200.

The rear panels of the SS-CDR200 and SS-R200 models have XLR balanced input and output connectors as well as RCA unbalanced input and output connectors. The input signal can be set to either the XLR balanced inputs or the RCA unbalanced inputs.

---

## Features

---

- 2-channel audio recorders can use USB memory, SD cards and CF cards
- SS-CDR200 units can also use CDs
- 1U rack-mount size
- Using USB memory, SD and CF cards, playback and recording of files in MP3 (44.1/48 kHz) and WAV formats is possible (44.1/48 kHz, 16/24-bit, 24-bit can only be played back)
- Using CD media, playback and recording of files in audio CD (CD-DA) and MP3 formats, as well as playback of WAV format files is possible (SS-CDR200 only)
- Built-in parallel and serial control ports can be used for remote control (SS-CDR200/SS-R200 only)
- Flash start function enables instant playback starting
- Pitch control, key control and other playback control functions
- Play area can be set as desired using playlists and folders
- Track editing (WAV files only)
- Built-in clock for time-stamping
- Balanced (SS-CDR200/SS-R200 only) and unbalanced analog audio inputs and outputs
- Coaxial digital audio inputs and outputs
- Included wired remote control allow reliable remote operation

- Control and character input using a PS/2 and USB keyboards possible
- Transport and pitch can be controlled using a TASCAM RC-3F footswitch (sold separately)
- Flash start using TASCAM RC-20 Direct Play Remote (sold separately) supported

---

## Included items

---

This product includes the following items.

Take care when opening the package not to damage the items. Keep the package materials for transportation in the future.

Please contact the retailer where you purchased this unit if any of these items are missing or have been damaged during transportation.

- Main unit..... 1
- AC power cord ..... 1
- RC-SS2 remote control unit (with 5 m cable) ..... 1
- A rack-mounting screw kit..... 1
- Security Screw kit..... 1
- Owner's manual (this manual) ..... 1

The warranty is included at the end of this manual.

---

## Conventions used in this manual

---

In this manual, we use the following conventions:

- The front panel illustration on the cover of this manual is an SS-CDR200. The SS-R200 and SS-R100 models have different appearances.
- The display screens shown in this manual are from the SS-CDR200. The SS-R200 and SS-R100 display screens are different in some cases.
- Buttons, jacks and other parts on the main unit and external devices are indicated like this: **HOME/ DISPLAY**
- Messages on the unit's display are shown like this: MOVE
- "USB flash drive" is abbreviated as "USB memory."
- "SD memory card" is abbreviated as "SD card."
- "CompactFlash card" is abbreviated as "CF card."
- CD-DA format is sometimes referred to as "audio CD" format. An audio disc containing tracks recorded in audio CD format is sometimes referred to as an "audio CD".
- A CD containing MP3 or WAV files is sometimes referred to as a "data CD".
- Additional information is provided as necessary as tips, notes and cautions.



## TIP

These are tips about how to use the unit.

## NOTE

These provide additional explanations and describe special cases.

## CAUTION

Failure to follow these instructions could result in injury, damage to equipment or lost recording data, for example.

---

## Intellectual property rights

---

- TASCAM is a trademark of TEAC Corporation, registered in the U.S. and other countries.
- SDHC Logo is a trademark of SD-3C, LLC.



- CompactFlash is a US registered trademark of SanDisk Corporation.
- Supply of this product does not convey a license nor imply any right to distribute MPEG Layer-3 compliant content created with this product in revenue-generating broadcast systems (terrestrial, satellite, cable and/or other distribution channels), streaming applications (via Internet, intranets and/or other networks), other content distribution systems (pay-audio or audio-on-demand applications and the like) or on physical media (compact discs, digital versatile discs, semiconductor chips, hard drives, memory cards and the like). An independent license for such use is required. For details, please visit <http://mp3licensing.com>.
- MPEG Layer-3 audio coding technology licensed from Fraunhofer IIS and Thomson.
- This product contains PrFILE<sup>®</sup>2 FAT file system and PrFILE2 Unicode Interface of eSOL Co., Ltd. Copyright © 2008 eSOL Co., Ltd.
- PrFILE<sup>®</sup> is a registered trademark of eSOL Co., Ltd. in Japan.
- Other company names, product names and logos in this document are the trademarks or registered trademarks of their respective owners.

Any data, including, but not limited to information, described herein are intended only as illustrations of such data and/or information and not as the specifications for such data and/or information. TEAC Corporation disclaims any warranty that any use of such data and/or information shall be free from infringement of any third party's intellectual property rights or other proprietary rights, and further, assumes no liability of whatsoever nature in the event of any such infringement, or arising from or connected with or related to the use of such data and/or information.

This product is designed to help you record and reproduce sound works to which you own the copyright, or where you have obtained permission from the copyright holder or the rightful licensor. Unless you own the copyright, or have obtained the appropriate permission from the copyright holder or the rightful licensor, your unauthorized recording, reproduction or distribution thereof may result in severe criminal penalties under copyright laws and international copyright treaties. If you are uncertain about your rights, contact your legal advisor. Under no circumstances will TEAC Corporation be responsible for the consequences of any illegal copying performed using the recorder.

---

## Precautions for placement and use

---

- The guaranteed operating temperature range of this product is 5° - 35° C (41° - 95° F).
- Do not install in the following types of places. Doing so could degrade the sound quality and/or cause malfunctions.
  - Places with significant vibrations or that are otherwise unstable
  - Near windows or other places exposed to direct sunlight
  - Near heaters or other extremely hot places
  - Extremely cold places
  - Places with bad ventilation or high humidity
  - Very dusty locations
- Make sure that the unit is mounted in a level position for correct operation.
- In order to promote the emission of heat, do not place anything on top of this product.
- Do not place this product on top of a powered amplifier or other equipment that emits heat.

# 1 – Introduction

---

## Connecting the power

---

- Insert the included power cord into the **AC IN** connector completely.
- Hold the power cord by the plug when connecting or disconnecting it.

---

## Beware of condensation

---

If the unit is moved from a cold to a warm place, or used immediately after a cold room has been heated or otherwise exposed to a sudden temperature change, condensation could occur. Should this happen, leave the unit for one or two hours before turning the unit on.

---

## Cleaning the unit

---

To clean the unit, wipe it gently with a soft dry cloth. Do not wipe with chemical cleaning cloths, benzene, paint thinner, ethyl alcohol or other chemical agents to clean the unit as they could damage the surface.

---

## About USB memory, SD cards and CF cards

---

This unit uses USB memory, SD cards and CF cards for playback and recording.

A list of USB memory, SD cards and CF cards that we have confirmed to work with this unit is provided on the TEAC Global Site (<http://teac-global.com/>).

---

## Precautions for use

USB memory, SD cards and CF cards are delicate media. In order to avoid damaging a memory/card or the memory/card slot, please take the following precautions when handling them.

- Do not leave them in extremely hot or cold places.
- Do not leave them in extremely humid places.
- Do not let them get wet.
- Do not put things on top of them or twist them.
- Do not hit them.
- Do not insert or remove a USB memory, SD card or CF card during recording, playback, data transfer or other operations that access a memory or card.
- Do not carry them with terminals exposed. Use the protective cover.

---

## Media that has been confirmed for use with this unit

This unit uses USB memory, SD cards and CF cards for playback and recording.

Microdrives cannot be used with this unit.

The capacities and performance of your unit will vary based on the speed and abilities of the media used. Older and some cheaper USB memory/SD cards/CF cards use slower memory components and little internal buffering which results in poor recording performance.

A list of USB memory/SD cards/CF cards that we have confirmed to work with this unit is provided on the TEAC Global Site (<http://teac-global.com/>).

---

## SD card write-protection

This unit writes track information to the media in order to improve performance. Since track data cannot be written to write-protected SD cards, media reading will take longer and performance could otherwise be affected.

---

## Media formatting

Flash media that has been formatted by this unit is optimized for performance during recording. Using flash media that has been formatted by a computer, for example, could result in errors during recording. We recommend that whenever possible you use flash media after it has been formatted by this unit.

---

## About compact discs

---

In addition to commercially-available music CDs, this unit can play CD-R and CD-RW discs that have been recorded in audio CD format, as well as CD-R and CD-RW discs that have MP3 audio and WAV audio files recorded on them.

---

## Handling of compact discs

- For recording, use compact discs that have one of the following marks.

CD-R



CD-RW



- Always insert the compact discs in the slot with their label facing upward.
- To remove a disc from its case, press down on the center of the disc holder, then lift the disc out, holding it carefully by the edges.
- Do not touch the signal side (the unlabeled side). Fingerprints, oils and other substances can cause errors during playback.

- To clean the signal side of a disc, wipe gently with a soft dry cloth from the center towards the outside edge. Dirt on discs can lower the sound quality, so clean them and always store them in a clean state.
- Do not use any record spray, anti-static solutions, benzene, paint thinner or other chemical agents to clean CDs as they could damage the delicate playing surface. It may cause CDs to become unplayable.
- Do not apply labels or other materials to discs. Do not use discs that have had tape, stickers or other materials applied to their surface. Do not use discs that have sticky residue from stickers, etc. Such discs could become stuck in the unit or cause it to malfunction.
- Never use a commercially available CD stabilizer. Using stabilizers with this player will damage the mechanism and cause it to malfunction.
- Do not use cracked discs.
- Only use circular compact discs. Avoid using non-circular promotional, etc. discs.

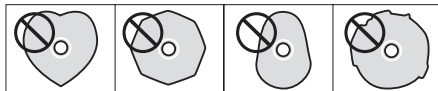

- Music discs with copy control, a copy-protection system, have been released from several record companies in an attempt to protect the copyright. Since some of these discs do not comply with the CD specifications, they may not be playable on the unit.
- If you are in any doubt as to the care and handling of a CD-R and CD-RW discs, read the precautions supplied with the disc, or contact the disc manufacturer directly.

## About CD-R and CD-RW discs

CD-R discs can be recorded once only. Once they have been used for recording, they cannot be erased or re-recorded. However, if space is available on the disc, additional material can be recorded.

By finalizing a CD-R that you have finished using for recording, you can make it playable by most ordinary CD players. (Some CD players might not be able to play back CD-R discs even if they are finalized.)

CD-RW discs allow recorded tracks to be erased to make space available again, allowing disc reuse. However, tracks can only be erased in the order from the last added. To erase a track in the middle, you must erase all the tracks added after it at the same time. Finalized CD-RW discs can only be played back in CD players that support CD-RW disc playback.

## Slot loading of discs

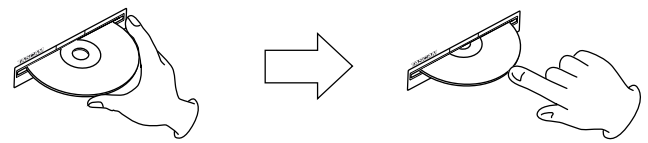

- 1 As shown in the illustration, hold the disc with the labeled side up and insert it part way into the slot.**
- 2 After you push the disc a little further, it will be pulled in automatically just before it disappears into the slot.**

### Trouble inserting a disc

If the disc becomes stuck during insertion, for example, and is difficult to push, do not try to force the disc in. Pull the disc out once and press the **EJECT** button and then try inserting it again. (Trying to force the disc in could damage the unit.)

## User registration

Customers in the USA, please visit the TASCAM website (<http://tascam.com/>) to register as a user online.

# 2 – Names and functions of parts

## Front panel

### SS-CDR200

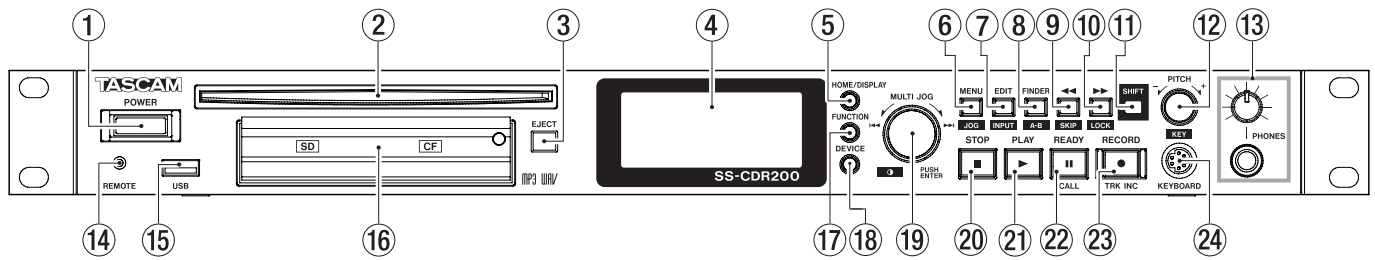

### SS-R200/SS-R100

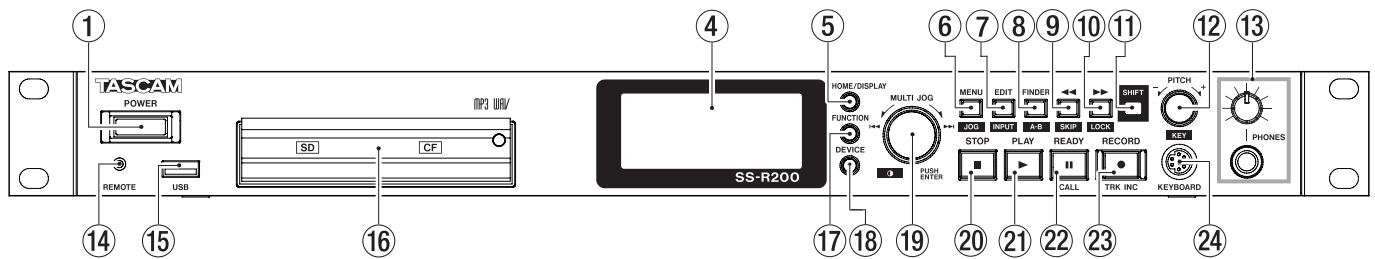

#### ① POWER switch

Turns the power on/off.

#### CAUTION

Before turning the power on, minimize the volume of other equipment that is connected to this unit. Failure to do so might cause sudden loud noises, which could harm your hearing or result in other trouble.

#### ② Disc slot (SS-CDR200 only)

Insert CDs here.

After a disc is inserted part way, it will automatically be pulled in.

#### ③ EJECT button (SS-CDR200 only)

Press this button to eject the disc.

#### ④ Display

This shows a variety of information.

#### ⑤ HOME/DISPLAY button

When a MENU or the FINDER screen is open, press this to return to the Home Screen.

Press when the Home Screen is open to change the Home Screen display mode. (See “Home Screen” on page 12 and “Recording Screen” on page 19.)

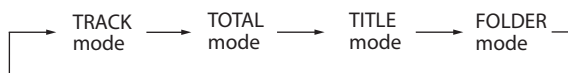

#### ⑥ MENU [JOG] button

Press this button when the Home Screen is open to open the MENU screen.

Press this button when the MENU screen is open to move a cursor on the right to the left. Press this button again to return to the Home Screen.

Press this button while pressing and holding the **SHIFT** button to set the jog playback mode. (See “Jog playback” on page 31.)

When in menu mode, press to go back one menu level.

#### ⑦ EDIT [INPUT] button

Press this button to put the unit into playback standby at current point and open the Edit Menu pop-up. (See “Using the Edit Menu” on page 57.)

Press this button while pressing and holding the **SHIFT** button to show the current input source. Press when the input source is shown to switch between the input source options. (See “Selecting the input source” on page 40.)

#### ⑧ FINDER [A-B] button

Press this button when the Home Screen is open to open the FINDER screen. (See “File and folder operations (FINDER screen)” on page 50.)

Press this button while pressing and holding the **SHIFT** button to start A-B repeat playback mode. (See “A-B repeat playback” on page 34.)

#### ⑨ ◀◀ [SKIP] button

During playback or when in playback standby, press and hold this button to search backward while outputting sound.

Press during playback or when in playback standby to skip backward by the set amount of time. (See “Skipping backward and forward” on page 31.)

When in menu mode, press to go back one menu level.

When the play area is set to **PLAYLIST**, press when stopped to select the current playlist.

When the play area is set to **FOLDER**, press when stopped or in recording standby to select the current folder.

## 2 – Names and functions of parts

When the **FINDER** screen is open, press this button after selecting a folder to return to a higher level. (See “Navigating the **FINDER** screen” on page 50.)

Press this button while pressing and holding the **SHIFT** button to open a pop-up window where you can set the skip time. (See “Skipping backward and forward” on page 31.)

When editing names, move the cursor backward.

When editing names, press this button while pressing and holding the **SHIFT** button to erase the character at the cursor position.

### ⑩ ►► [LOCK] button

During playback or when in playback standby, press and hold this button to search forward while outputting sound.

Press during playback or when in playback standby to skip forward by the set amount of time. (See “Skipping backward and forward” on page 31.)

When in menu mode, press to advance to the next level.

When the play area is set to **PLAYLIST**, press when stopped to select the current playlist.

When the play area is set to **FOLDER**, press when stopped or in recording standby to select the current folder.

When the **FINDER** screen is open, press this button after selecting a folder to show the contents of the folder. (See “Navigating the **FINDER** screen” on page 50.)

Press this button while pressing and holding the **SHIFT** button to turn ON/OFF the panel lock function, which disables the buttons on the front panel. (See “Panel lock function” on page 27.)

When editing names, move the cursor to the next item.

When editing names, press this button while pressing and holding the **SHIFT** button to insert a space. (See “Inputting and editing characters” on page 48.)

### ⑪ **SHIFT** button

If you press a button with a blue label while pressing and holding this button, that button will function according to that label. Press this button by itself to scroll information (track titles on the Home Screen and file and folder names on the **FINDER** screen) across the display.

### ⑫ **PITCH [KEY] knob**

Turn this knob to adjust the pitch (playback speed). Press this knob to turn pitch control ON/OFF. Press and hold this knob to open the **PITCH STEP X.X%** pop-up. (See “Pitch control playback” on page 32.)

Turn this knob while pressing and holding the **SHIFT** button to adjust the key level.

Press this while pressing and holding the **SHIFT** button to turn key control ON/OFF. (See “Key control playback” on page 33.)

### ⑬ **PHONES jack/knob**

Use this standard stereo jack to connect stereo headphones.

Use the **PHONES** knob to adjust the headphones output level.

### CAUTION

Before connecting headphones, minimize the volume with the **PHONES** knob. Failure to do so might cause sudden loud noises, which could harm your hearing or result in other trouble.

### ⑭ **REMOTE jack (2.5 mm dia TRS)**

Connect a TASCAM RC-3F footswitch or TASCAM RC-20 Direct Play Remote control (both designed for use with this unit and sold separately) here to enable remote control of playback starting and stopping, for example. When a TASCAM RC-3F footswitch is connected, the functions of the three pedals can be changed. (See “Footswitch control” on page 71.)

### ⑮ **USB port**

Connect USB memory, here to record to it and playback files on it.

Connect a USB keyboard to input file names, for example.

By default, the recorder is set use an English keyboard. To use Japanese keyboards, which are arranged differently from English keyboards, change the setting in the **UTILITY** menu. (See “Setting the keyboard language” on page 74.)

### ⑯ **SD and CF card slots**

Insert and eject SD and CF cards from here. (See “Inserting and ejecting SD and CF cards” on page 25.)

### ⑰ **FUNCTION button**

Press this button when the Home Screen is open to open the **FUNCTION** screen.

Use to select and deselect files to copy or move between a CD and the USB memory, SD card or CF card. (See “Copying files between CDs and other media (SS-CDR200)” on page 63.)

### ⑱ **DEVICE button**

Press this button when the Home Screen is open to open the **DEVICE SELECT** screen. (See “Selecting the device used” on page 26.)

### ⑲ **MULTI JOG dial**

This functions both as a dial and as a button.

#### [Dial functions]

When the Home Screen is open, turn to select tracks.

When inputting a program, turn to select tracks to add.

When in menu mode, use to select menu items and setting values.

When editing names, use to select characters.

When jogging during playback, use to move between frames. (See “Jog playback” on page 31.)

## 2 – Names and functions of parts

While pressing and holding the **SHIFT** button, turn the **MULTI JOG** dial to adjust the display contrast.

### [Button functions]

Use to confirm selections and settings (**ENTER** function).

Press when the **FINDER** screen is open to open the **FINDER** menu pop-up for the selected folder or file. (See “File operations” and “Folder operations” on page 51.)

#### ⑳ **STOP button**

Stops playback and recording.

In **PROGRAM** playback mode, press when stopped to clear the entire program.

#### ㉑ **PLAY button/indicator**

Press when stopped or in playback standby to start playback.

Press in recording standby to start recording.

During playback or recording, this button lights.

When jogging during playback, this button blinks.

#### ㉒ **READY [CALL] button/indicator**

Press when stopped or during playback to switch to playback standby.

Press when recording to switch to recording standby.

The button lights when in playback standby and recording standby.

The button blinks when jogging during playback.

When in playback standby, press this button to search for the call point (point from where playback last started from playback standby) and switch to playback standby. (See “Call function” on page 31.)

#### ㉓ **RECORD [TRK INC] button/indicator**

Press when stopped to start recording standby.

Press when recording to start a new track and continue recording without interruption.

The button lights when recording and in recording standby.

Press when there is no media in the current device to activate input monitoring, causing the currently selected input signal to be output. The button blinks during input monitoring.

#### ㉔ **KEYBOARD connector**

Connect an IBM PC-compatible keyboard with a PS/2 interface here.

By default, the recorder is set to use an English keyboard. To use Japanese keyboards, which are arranged differently from English keyboards, change the setting in the **UTILITY** menu. (See “Setting the keyboard language” on page 74.)

## 2 – Names and functions of parts

### Rear panel

#### SS-CDR200/SS-R200

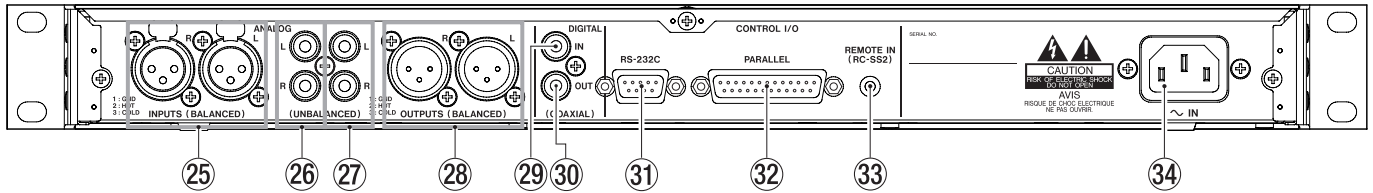

#### SS-R100

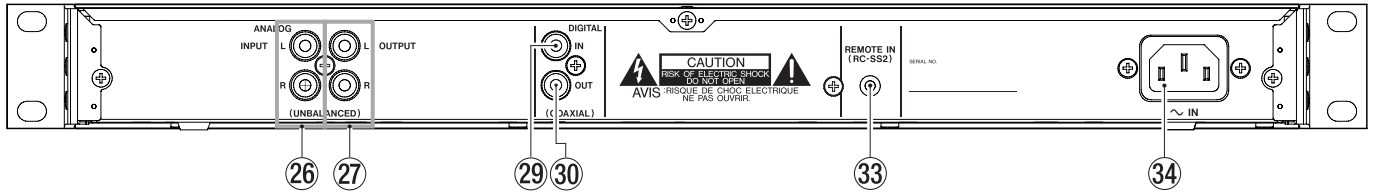

#### 25 ANALOG L/R INPUTS (BALANCED) (SS-CDR200/SS-R200 only)

These balanced analog XLR input connectors have a nominal input level of +4 dBu.

(1: GND, 2: HOT, 3: COLD)

#### 26 ANALOG L/R INPUTS (UNBALANCED)

These analog RCA pin input jacks have a nominal input level of –10 dBV.

#### 27 ANALOG L/R OUTPUTS (UNBALANCED)

These analog RCA pin output jacks have a nominal output level of –10 dBV.

#### 28 ANALOG L/R OUTPUTS (BALANCED) (SS-CDR200/SS-R200 only)

These balanced analog XLR output jacks have a nominal output level of +4 dBu.

(1: GND, 2: HOT, 3: COLD)

#### 29 DIGITAL IN (COAXIAL)

This digital input jack accepts inputs in IEC60958-3 (S/PDIF) and AES3-2003/IEC60958-4 (AES/EBU) formats (detected automatically).

To link two of these units together, connect the **DIGITAL OUT** jack of the other SS-CDR200/SS-R200/SS-R100 to this connector. (See “Link playback connections” on page 38.)

#### 30 DIGITAL OUT (COAXIAL)

This digital output jack can output IEC60958-3 (S/PDIF) and AES3-2003/IEC60958-4 (AES/EBU) formats according to the unit’s setting.

To link two of these units together, connect the **DIGITAL IN** jack of the other SS-CDR200/SS-R200/SS-R100 to this connector. (See “Link playback connections” on page 38.)

#### 31 CONTROL I/O RS-232C connector (SS-CDR200/SS-R200 only)

This 9-pin D-sub I/O connector for RS-232C control can be connected to a computer or other external device. (See “Using the RS-232C connector” on page 76.)

#### 32 CONTROL I/O PARALLEL connector (SS-CDR200/SS-R200 only)

25-pin D-sub I/O connector for parallel control can be used to connect an RC-SS20 (sold separately) or other external controller.

For pin assignments and other information, see “Using the parallel connector” on page 76.

#### 33 REMOTE IN connector

Connect the included TASCAM RC-SS2 wired remote control, which is designed for use with this unit, here.

#### 34 AC IN connector

Connect the included power cord here.

## 2 – Names and functions of parts

### TASCAM RC-SS2 wired remote control

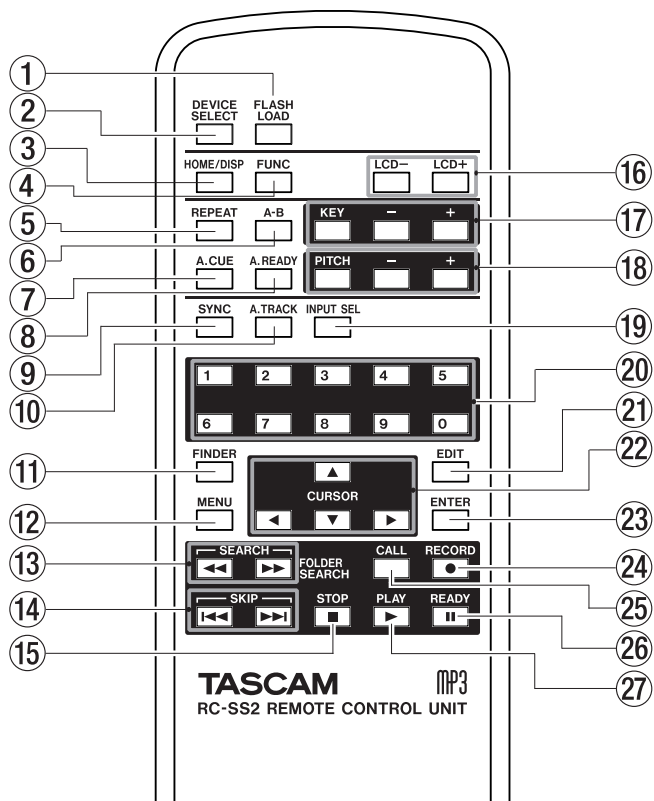

**1 FLASH LOAD button**

This loads the registered tracks in preparation for Flash Start. When the tracks are loaded, **FS** will appear on the Home Screen. (See “Flash Start function” on page 38.)

**2 DEVICE SELECT button**

This has the same function as the front panel **DEVICE** button.

**3 HOME/DISP button**

This has the same function as the front panel **HOME/DISPLAY** button.

Press when the Home Screen is open to change the Home Screen display mode. (See “Home Screen” on page 17.)

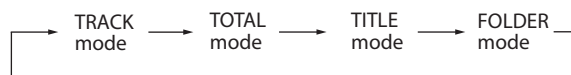

**4 FUNC button**

This has the same function as the front panel **FUNCTION** button.

**5 REPEAT button**

Turns the repeat playback function ON/OFF. (See “Ordinary repeat playback” on page 33.)

**6 A-B button**

Use for A-B repeat playback operations. (See “A-B repeat playback” on page 34.)

**7 A.CUE button**

Turns the Auto Cue function ON/OFF. (See “Auto Cue function” on page 34.)

**8 A.READY button**

Turns the Auto Ready function ON/OFF. (See “Auto Ready function” on page 35.)

**9 SYNC button**

Turns sync recording ON/OFF. (See “Sync recording” on page 43.)

**10 A.TRACK button**

Switches the Auto Track mode between OFF, LEVEL, DD and TIME. (See “Auto Track function” on page 45.)

**11 FINDER button**

Opens the **FINDER** or **USER PLAYLIST** screen depending on the play area setting. (See “Opening the FINDER screen” on page 50 and “Editing the playlist (USB/SD/CF media only)” on page 60.)

**12 MENU button**

This has the same function as the front panel **MENU [JOG]** button.

**13 SEARCH (◀◀ and ▶▶) buttons**

These have the same functions as the front panel **◀◀ [SKIP]/▶▶ [LOCK]** buttons. However, they do not function in menu mode.

**14 SKIP (◀◀ and ▶▶) buttons**

These have the same functions as turning the front panel **MULTI JOG** dial.

**15 STOP buttons**

This has the same function as the front panel **STOP** button.

**16 LCD (-/+ ) buttons**

These adjust the contrast of the display. (See “Adjusting the display contrast” on page 24.)

**17 KEY (-/+ ) buttons**

The **KEY** button has the same function as pressing the front panel **PITCH** knob while pressing and holding the **SHIFT** button.

The **-/+** buttons to the right of the **KEY** button have the same functions as turning the front panel **PITCH** knob while pressing and holding the **SHIFT** button. (See “Key control playback” on page 33.)

**18 PITCH (-/+ ) buttons**

The **PITCH** button has the same function as pressing the front panel **PITCH** knob.

The **-/+** buttons to the right of the **PITCH** button have the same functions as turning the front panel **PITCH** knob. (See “Pitch control playback” on page 32.)

**19 INPUT SEL button**

This selects the recording input source. You can choose unbalanced (RCA), balanced (XLR, SS-CDR200/SS-R200 only) or coaxial. (See “Selecting the input source” on page 40.)

Balanced (XLR) cannot be selected on the SS-R100.

**20 Number buttons**

Use these to select tracks. (See “Specifying a track number” on page 30.)



## 2 – Names and functions of parts

### 21 EDIT button

Press this button to start playback standby at the current position and open the Edit Menu pop-up. (See “Using the Edit Menu” on page 57.)

Press when entering a track number to clear the entire number input.

During program input, press to clear the track number being added. At other times, the last-added track will be cleared from the program. (See “Program playback” on page 32.)

### 22 ▲/▼/◀/▶ buttons

Use to operate the menus.

The ▲/▼ buttons select the items and values above and below.

When in menu mode, use the ◀ button to return upward through the menu structure, and use the ▶ button to proceed in the menu structure.

When the FINDER screen is open, use the ◀ button to move up a level in the folder structure and the ▶ button to enter a folder. (See “Navigating the FINDER screen” on page 50.)

### 23 ENTER button

This has the same function as pressing the front panel **MULTI JOG** dial.

### 24 RECORD button

This has the same function as the front panel **RECORD** button.

### 25 CALL button

Searches for the call point (point from where playback last started from playback standby) and starts playback standby. (See “Call function” on page 31.)

### 26 READY button

This has the same function as the front panel **READY** button.

### 27 PLAY button

This has the same function as the front panel **PLAY** button.

## Home Screen

The Home Screen has TRACK, TOTAL, TITLE and FOLDER display modes.

Each time you press the **HOME/DISPLAY** button (or remote control **HOME/DISP** button), the information shown in the center of the display changes.

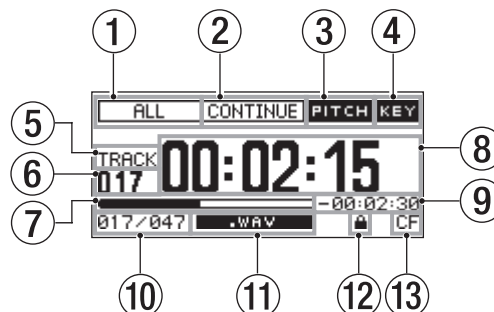

Home Screen TRACK mode

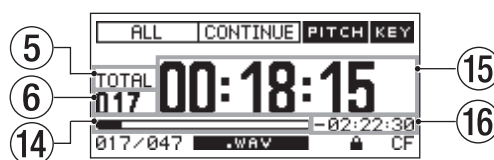

Home Screen TOTAL mode



Home Screen TITLE mode

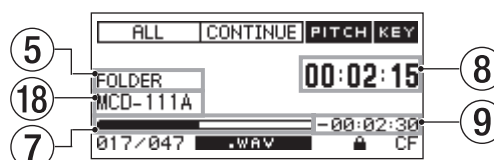

Home screen FOLDER mode

### 1 Play area

Shows the current play area of the current file.

ALL : All files on the media in the current device

FOLDER : All files in the selected folder

PLAYLIST : All files added to the playlist

### 2 Playback mode

Shows the current playback mode.

CONTINUE : Continuous playback mode

SINGLE : Single playback mode

PROGRAM : Program playback mode

RANDOM : Random playback mode

## 2 – Names and functions of parts

### ③ PITCH indicator

When the pitch control function is on, the **PITCH** indicator appears.

### ④ KEY indicator

When the key control function is on, the **KEY** indicator appears.

### ⑤ Display mode

Shows the display mode currently shown on the Home Screen.

### ⑥ Track number

Shows the number of the track being played back.

### ⑦ Track playback position

Shows the current playback position as a bar. As playback elapses, the bar extends from the left.

### ⑧ Track elapsed time

Shows the elapsed time (hours: minutes: seconds) of the current track.

### ⑨ Track remaining time

Shows the remaining time (hours: minutes: seconds) of the current track.

### ⑩ Track number/total number of tracks

Shows the current track number and the total number of tracks in the current play area.

### ⑪ File format

Shows the format of the current playback file.

### ⑫ SD card protection icon

This icon appears when an SD card that is write-protected is loaded and the current device is set to SD.

### ⑬ Current device

Shows the currently selected device.

### ⑭ Total playback position

Shows the current playback position as a bar. As playback elapses, the bar extends from the left. On this screen, this bar represents the entire play area.

### ⑮ Total track elapsed time

Shows the elapsed time (hours: minutes: seconds) of the current play area.

### ⑯ Total track remaining time

Shows the remaining time (hours: minutes: seconds) of the current play area.

### ⑰ Track title

Shows the title of the current track. Press the SHIFT button to make this scroll across the display.

### ⑱ Current playback folder name

Shows the name of the folder that contains the file currently being played back.

#### NOTE

- When stopped, the total playback time of the play area is always shown, regardless of the current Home Screen display mode.
- When using a CD-R/CD-RW disc with MP3 or WAV files that were recorded using a computer or other equipment besides this unit, the total time when

stopped, and the total elapsed time and total remaining time during playback will not be shown. (Only the number of tracks and track number are shown. “– –” appears in the time display area.). However, after all tracks have been played back by this unit, the time will appear.

- In PROGRAM playback mode, the elapsed time and remaining time are shown for the entire program, not the entire play area.

### Home Screen FUNCTION status display

When the Home Screen is open, press the **FUNCTION** button (or remote control **FUNC** button) to open the **FUNCTION** screen.

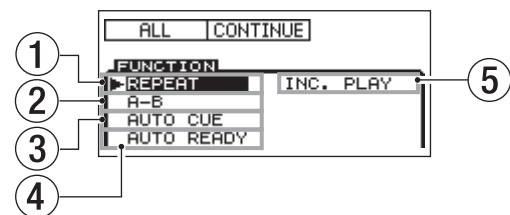

Home Screen FUNCTION status display

On the **FUNCTION** screen, you can check and change the ON/OFF status of all items in the **PLAY** menu on one screen. Items that are ON appear light on dark.

#### NOTE

When the **FUNCTION** screen is open, press the **FUNCTION** button (or remote control **FUNC** button) to return to the Home Screen.

The following items appear on the **FUNCTION** screen.

No.	Function	Reference
①	Repeat playback setting	Page 33
②	A-B repeat playback setting	Page 34
③	Auto Cue setting	Page 34
④	Auto Ready setting	Page 35
⑤	Incremental playback setting	Page 35

#### NOTE

The “A-B” item only appears when A-B repeat has been set.

### Changing item settings on the FUNCTION screen

- When the **FUNCTION** screen is open, turn the **MULTI JOG** dial (or press the remote control **▲/▼** buttons), to move the **▶** to the item you want to set.
- Press the **MULTI JOG** dial (or remote control **ENTER** button) to turn the selected item ON/OFF. When on, the item appears light on dark.

## 2 – Names and functions of parts

### Recording Screen

The Recording Screen has TRACK, TOTAL, TITLE and FOLDER display modes.

Each time you press the **HOME/DISPLAY** button (or remote control **HOME/DISP** button), the information shown in the center of the display changes.

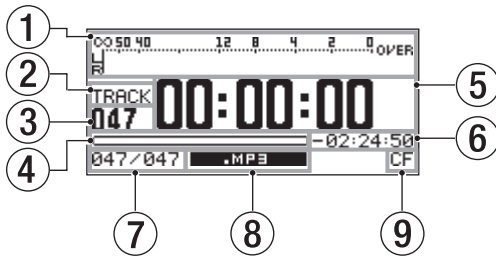

Recording Screen TRACK mode

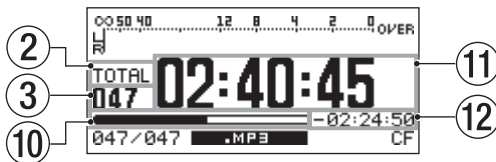

Recording Screen TOTAL mode

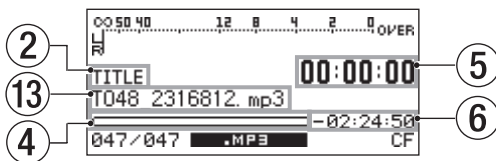

Recording Screen TITLE mode

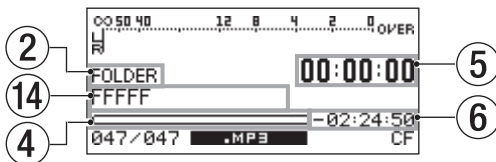

Recording Screen FOLDER mode

- ① **Input level**  
Shows the input sound level.
- ② **Display mode**  
Shows the display mode currently shown on the Recording Screen.
- ③ **Track number**  
Shows the number of the track being recorded.
- ④ **Track recording position**  
Shows the current recording position as a bar. As recording elapses, the bar extends from the left. On this screen, this bar represents maximum file size 2 GB.
- ⑤ **Track recorded time**  
Shows the recorded time (hours: minutes: seconds) of the file being recorded.
- ⑥ **Track recording remaining time**  
Shows the remaining possible recording time (hours: minutes: seconds) for the maximum file size of 2GB.

- ⑦ **Track number/total number of tracks**  
Shows the total number of tracks and the current track number in the current play area.
- ⑧ **File type**  
Shows the current recording file format.
- ⑨ **Current device**  
Shows the currently selected device.
- ⑩ **Total recording position**  
Shows the current recording position as a bar. As recording elapses, the bar extends from the left. On this screen, this bar represents total media capacity.
- ⑪ **Total track recorded time**  
Shows the total recorded time (hours: minutes: seconds) on the current media.
- ⑫ **Total track remaining time**  
Shows the total remaining possible recording time (hours: minutes: seconds) of the current media.
- ⑬ **Track title**  
Shows the title of the track being recorded.
- ⑭ **Current folder name**  
Shows the name of the folder that contains the file currently being recorded.

#### NOTE

The remaining time depends on the recording format (REC FORMAT item in the REC menu).

### Recording Screen FUNCTION status display

In recording standby or when recording press the **FUNCTION** button (or remote control **FUNC** button) to open the **FUNCTION** screen.

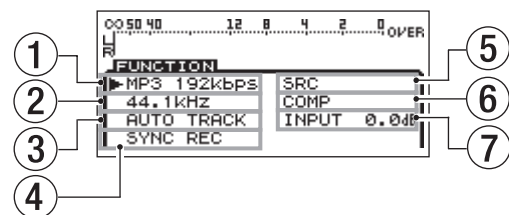

Recording Screen FUNCTION status display

On the Recording **FUNCTION** screen, you can check and change the ON/OFF status of all items in the REC menu on one screen. Items that are ON appear light on dark.

#### NOTE

When the Recording **FUNCTION** screen is open, press the **FUNCTION** button (or remote control **FUNC** button) to return to the Recording Screen.

## 2 – Names and functions of parts

The following items appear on the Recording FUNCTION screen.

No.	Function	Reference
①	Recording file format setting	Page 41
②	Sampling frequency setting	Page 41
③	Auto Track setting	Page 45
④	Sync recording setting	Page 43
⑤	Sampling rate converter setting	Page 41
⑥	Compressor setting	Page 47
⑦	Input level setting	Page 42

### ■ Changing item settings on the recording FUNCTION screen

- 1 When the FUNCTION screen is open, turn the MULTI JOG dial (or press the remote control ▲/▼ buttons) to move the ► to the item you want to set.
- 2 For the MP3 192kbps, 44.1kHz, AUTO TRACK and COMP items, press the MULTI JOG dial (or remote control ENTER button) to change the setting of the selected item.

For the SYNC REC and SRC items, press the MULTI JOG dial (or remote control ENTER button) to turn the selected item ON/OFF. When ON, the item appears selected (light on dark).

For the INPUT 0.0dB item, press the MULTI JOG dial (or remote control ENTER button) and then turn the MULTI JOG dial (or press the remote control ▲/▼ buttons) to change the input level. After changing the setting, press the MULTI JOG dial (or remote control ENTER button) to confirm the setting.

The submenu items are as follows.

Main menu item	Submenu item	Function	Reference
PLAY	PLAY AREA	Play area settings	Page 28
	PLAY MODE	Playback mode settings	Page 29
	P.L.EDIT	Playlist editing	Page 60
	REPEAT	Repeat playback function settings	Page 33
	AUTO CUE	Auto Cue settings	Page 34
	AUTO READY	Auto Ready settings	Page 35
	INC.PLAY	Incremental playback settings	Page 35
REC	OTHERS	Other playback settings	—
	INPUT SELECT	Input source selection	Page 40
	INPUT VOLUME	Input volume settings	Page 42
	REC FORMAT	Recording file format settings	Page 41
	SYNC	Sync recording settings	Page 43
	AUTO TRACK	Auto Track increment settings	Page 45
	OTHERS	Other recording settings	—

### Menu structure

Press the MENU [JOG] button or the MENU button on the included TASCAM RC-SS2 remote control to open the MENU screen.

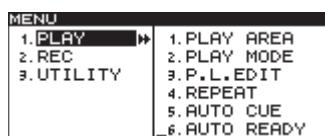

MENU screen when USB/SD/CF media selected

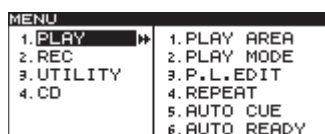

MENU screen when CD media selected (SS-CDR200 only)

The MENU has three or four main items.

PLAY: Items related to playback

REC: Items related to recording

UTILITY: Items related to unit settings, etc.

CD: Items related to CD operations (SS-CDR200 only)

## 2 – Names and functions of parts

Main menu item	Submenu item	Function	Reference
UTILITY	MEMORY FORMAT	Format USB, SD, and CF media	Page 27
	BRIGHTNESS	Display and indicator brightness settings	Page 24
	KEYBOARD	Keyboard type setting	Page 74
	CLOCK ADJUST	Time setting	Page 24
	RS-232C	RS-232C setting	Page 76
	RC-3F MODE	Footswitch mode setting	Page 71
	DIGITAL OUT	Digital output settings	Page 71
	A. OUT ATT.	Analog output attenuation setting	Page 72
	INFORMATION	Show information about the operating time and media	Page 72
	FACTORY PRESET	Restore the factory settings	Page 72
VERSION	Show firmware versions	Page 73	
CD	FINALIZE	Finalize and unfinalize CD-R/CD-RW disc	Page 43
	ERASE	Erase a written CD-RW disc	Page 69
	BURN TO CD	Write from the selected media to a CD-R/CD-RW disc	Page 64
	RIP TO MEMORY	Write from a CD to the selected media	Page 66

The PLAY OTHERS submenu items are as follows.

PLAY OTHERS menu item	Function	Reference
MONO MIX	Mono playback setting	Page 36
EOM TRACK	EOM function setting	Page 36
EOM MEDIA	EOM function setting	Page 36
RESUME	Resume playback setting	Page 37
POWER ON PLAY	Power-on play setting	Page 37
LINK	Link playback setting	Page 37

The RECORDING OTHERS submenu items are as follows.

REC OTHERS menu item	Function	Reference
PAUSE MODE	Pause mode setting	Page 46
SRC	Sampling rate converter setting	Page 41
WORD CLIP	Recording file name setting	Page 47
COMP	Compressor setting	Page 47
DITHER	Dither setting	Page 48

### Menu operation basics

You can perform the following operations in the menus.

#### To select an item (vertically on the screen):

Turn the **MULTI JOG** dial.

Use the cursor **▲** and **▼** buttons on the remote control.

#### To confirm the selected item:

Press the **MULTI JOG** dial.

Press the **ENTER** key on the remote control.

#### To move the cursor left/right:

Use the **◀◀ [SKIP]/▶▶ [LOCK]** buttons.

Use the cursor **◀/▶** buttons of the remote control.

#### To open a sub-screen not currently shown on the display (▶▶ is shown at the right):

Press the **MULTI JOG** dial or **▶▶ [LOCK]** button.

Press the **ENTER** or **▶** button of the remote control.

#### To go back one menu level:

Press the **MENU [JOG]** or **◀◀ [SKIP]** button.

Press the **MENU** or **◀** button of the remote control.

#### To return directly to the Home Screen from menu mode:

Press the **HOME/DISPLAY** button.

Press the **HOME/DISP** button on the remote control.

#### NOTE

If there are items above or below the currently displayed items in the list, **▲** and/or **▼** will be shown at the top and/or bottom of the list.

### Menu operation procedures

This example explains sync recording setting.

#### NOTE

- The front panel illustrations shown below are of the SS-CDR200 model. The SS-R200 and SS-R100 models have different appearances.
- The display screens shown below are from the SS-CDR200. The SS-R200 and SS-R100 display screens are different in some cases.

#### 1 Use the main unit or the included TASCAM RC-SS2 remote control to open the MENU screen.

##### Front panel operation:

Press the **MENU [JOG]** button.

##### Remote control operation:

Press the **MENU** button.

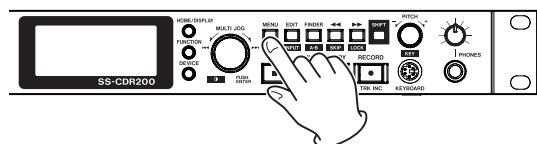

## 2 – Names and functions of parts

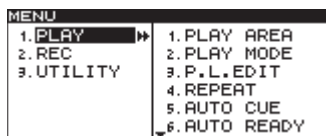
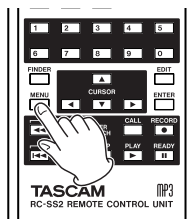

### 2 Open the REC menu.

#### Front panel operation:

Turn the **MULTI JOG** dial to select **REC**, and press the **MULTI JOG** dial or ►► [LOCK] button.

#### Remote control operation:

Use the ▲ and ▼ buttons to select **REC**, and press the **ENTER** or ► button.

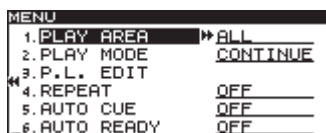
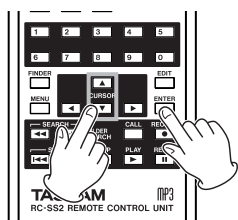
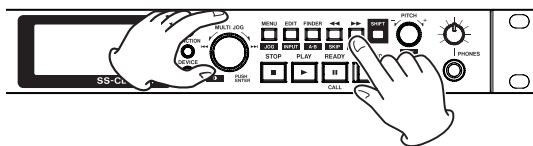

### 3 Select the SYNC item setting.

#### Front panel operation:

Turn the **MULTI JOG** dial to select **SYNC**, and press the **MULTI JOG** dial or ►► [LOCK] button.

#### Remote control operation:

Use the ▲ and ▼ buttons to select **SYNC**, and press the **ENTER** or ► button.

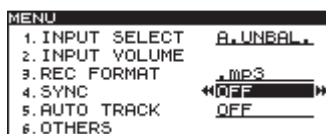

### 4 Set SYNC to ON or OFF.

#### Front panel operation:

Turn the **MULTI JOG** dial to select **ON**.

#### Remote control operation:

Use the ▲ and ▼ buttons to select **ON**.

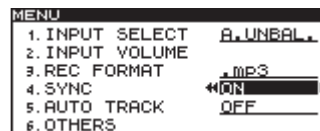

### 5 Open the SYNC screen where you can make detailed settings.

#### Front panel operation:

Press the **MULTI JOG** dial or ►► [LOCK] button.

#### Remote control operation:

Press the **ENTER** or ► button.

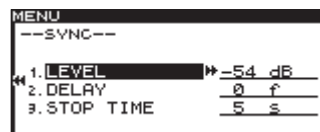

### 6 Select the item on the SYNC screen to set.

#### Front panel operation:

Turn the **MULTI JOG** dial to select the item.

#### Remote control operation:

Use the ▲ and ▼ buttons to select the item.

### 7 Move the cursor to the setting.

#### Front panel operation:

Press the **MULTI JOG** dial or ►► [LOCK] button.

#### Remote control operation:

Press the **ENTER** or ► button.



### 8 Change the setting value.

#### Front panel operation:

Turn the **MULTI JOG** dial to change the value.

#### Remote control operation:

Use the ▲ and ▼ buttons to change the value.

### 9 To change another item on the same screen, press the ◀◀ [SKIP] button (or remote control ◀ button) to return to setting item selection. Use the MULTI JOG dial (or remote control ▲/▼ buttons) to select the item you want to set.

### 10 As necessary, repeat steps 7–9 to set each item as you want.

### 11 Return to the Home Screen.

#### Front panel operation:

Press the **HOME/DISPLAY** button.

#### Remote control operation:

Press the **HOME/DISP** button.

# 3 – Preparations

## Making connections

The following example shows connections with an SS-CDR200.

Precautions before making connections

- Before making connections, read the operation manuals of the other equipment carefully and connect each one correctly.
- Turn OFF (or put in standby) the power of this unit and all other devices before connecting them.
- Connect all the devices to the same power supply line. When using a power strip, for example, use a thick cable with a high current capacity to minimize variation in the power voltage.

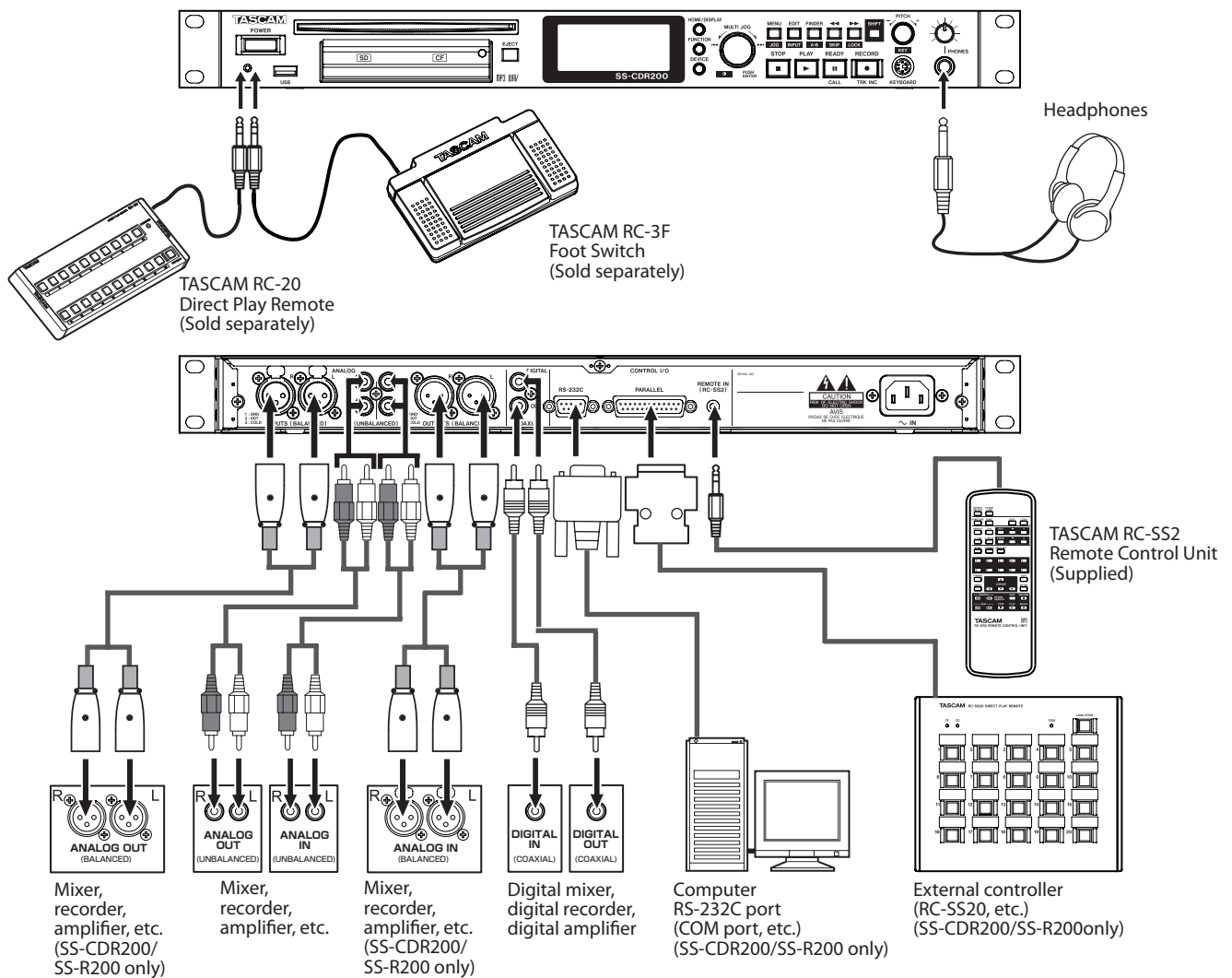

## 3 – Preparations

### Turning the power ON/OFF

Press the front panel **POWER** switch to turn the power ON.

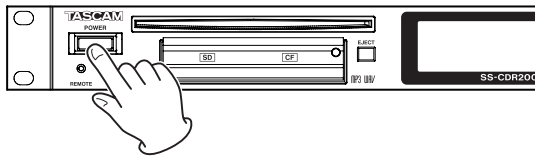

Startup screen



Home Screen

The unit starts up and the startup screen appears. (The example above is from an SS-CDR200.)

If no media is loaded in the current device, a **NO MEDIA** message appears.

If media is loaded in the current device, a **MEDIA READING** message appears while the unit reads the media. When completed, the Home Screen opens.

#### Turning the power OFF:

Press the **POWER** switch to turn the power OFF. No special shutdown procedures are necessary.

#### CAUTION

Do not turn the power OFF when the unit is in use (recording, playing back, writing data to USB/SD/CF media, etc.). Doing so could cause recording to fail, recorded data to be damaged, sudden loud noise to be emitted from monitoring equipment, damage to equipment and harm to hearing.

### Setting the date and time

The date and time is added to the recorded file based on the built-in clock.

- 1 Press the **MENU [JOG] button** (or remote control **MENU** button) to open the **MENU** screen.

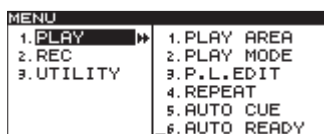

- 2 Open the **UTILITY** menu.

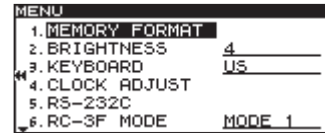

#### NOTE

The screen above is an example from an SS-CDR200 or SS-R200 unit.

The SS-R100 does not have the 5. RS-232C menu item.

- 3 Select **CLOCK ADJUST**.



- 4 Press the **MULTI JOG** dial or **▶▶ [LOCK]** button (or remote control **ENTER** or **▶** button) to open the **CLOCK ADJUST** screen.

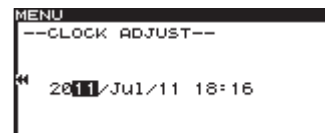

- 5 Set the date and time with the following operations.

- Use the **◀◀ [SKIP]** and **▶▶ [LOCK]** buttons (or remote control **◀** and **▶** buttons) to select the item you want to set.
- Turn the **MULTI JOG** dial (or press the remote control **▲** and **▼** buttons) to change the selected item.

- 6 After making the setting, press the **MULTI JOG** dial (or remote control **ENTER** button) to confirm the date and time and return to the **UTILITY** menu.
- 7 Press the **HOME/DISPLAY** button (or remote control **HOME/DISP** button) to return to the Home Screen.

### Adjusting the display

You can adjust the display contrast and brightness as necessary.

#### Adjusting the display contrast

While pressing and holding the **SHIFT** button, turn the **MULTI JOG** dial (or press the remote control **LCD +/-** buttons) to adjust the display contrast.

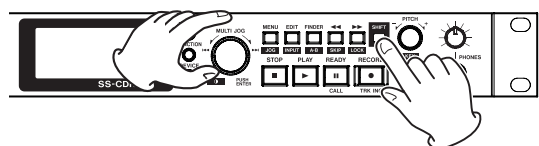



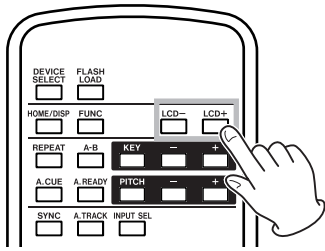

## Adjusting the display and indicator brightness

Use the **BRIGHTNESS** item of the **UTILITY** menu to adjust the brightness of the display backlight and **PLAY**, **READY** and **RECORD** button indicators.

- 1 Press the **MENU [JOG]** button (or remote control **MENU** button) to open the **MENU** screen.
- 2 Open the **UTILITY** menu.
- 3 Select **BRIGHTNESS**.



### NOTE

- The screen above is an example from an **SS-CDR200** or **SS-R200** unit.
  - The **SS-R100** does not have the 5. **RS-232C** menu item.
- 4 Press the **MULTI JOG** dial or **▶▶ [LOCK]** button (or remote control **ENTER** or **▶** button) to move the cursor to the right and select the value.



- 5 Turn the **MULTI JOG** dial (or press the remote control **▲/▼** buttons) to adjust the brightness.
- 6 Press the **HOME/DISPLAY** button (or remote control **HOME/DISP** button) to return to the Home Screen.

### NOTE

The display and indicator **BRIGHTNESS** setting is retained even after the power is turned OFF.

## Inserting and ejecting SD and CF cards

### Inserting SD and CF cards

Insert an SD card or CF card into the appropriate card slot on the front panel to use it for playback and recording.

### NOTE

You can insert SD and CF cards regardless of whether the power is ON or OFF.

- 1 Pull the card slot door forward to open it.

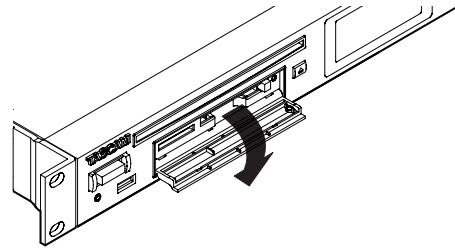

- 2 Insert the SD/CF card with the correct orientation. The label should be facing up and the contacts facing in.

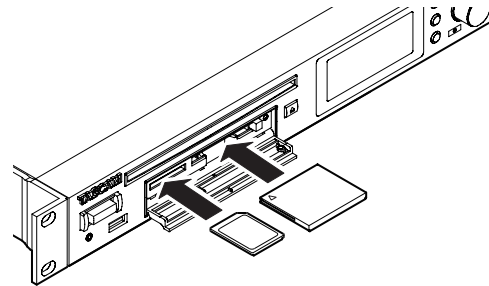

- 3 Close the card slot door.

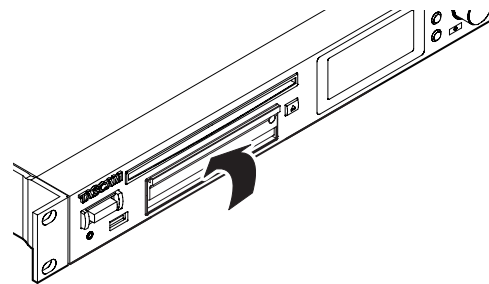

### NOTE

If the SD/CF card slot door will not close, remove the card, and then insert it once again. To remove an SD card, pull it. To remove a CF card, press the square button located at the right of the slot.

### Ejecting SD and CF cards

Turn the power OFF or stop operation before ejecting an SD or CF card.

### CAUTION

Never remove an SD or CF card when the unit is in use (recording, playing back, writing data to a card, etc.). Doing so could cause recording to fail, recorded data to be damaged, sudden loud noise to be emitted from monitoring equipment, damage to equipment and harm to hearing.

- 1 Pull the card slot door forward to open it.
- 2 To eject an SD card, press the SD card in slightly. To eject a CF card, press the square button located at the right of the card slot. The button will come out. Push it in again to eject the CF card partially.

## 3 – Preparations

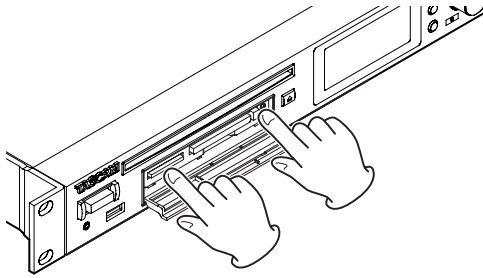

3 Pull the SD or CF card out the rest of the way.

### Using the security screw

The included security screw can be used to lock the card slot door.

Use a Phillips screwdriver to install or remove the security screw.

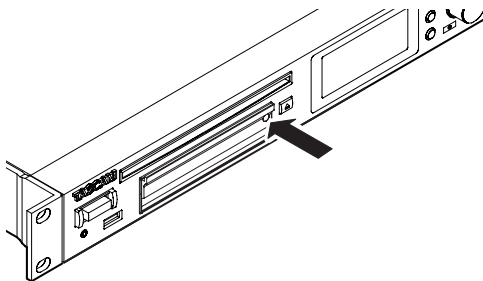

### SD card write protection

SD cards have write-protection switches.

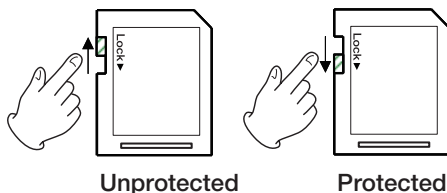

If the protection switch is slid into the "LOCK" position, adding and editing files will not be possible. To record, erase or otherwise change files, disable write protection.

#### NOTE

When using a protected SD card, every time the device is changed, the audio files on the card will be checked beforehand. For this reason, changing devices takes time. Moreover, editing the playlist and other operations are not possible.

### Inserting and removing discs (SS-CDR200 only)

#### Inserting discs

With the disc label up, insert it partway into the disc slot. Push the disc in a little further and it will be pulled in automatically just before it disappears into the slot.

After the disc is inserted, the unit reads the disc information. The total number of tracks and total playback time of an audio CD will be shown. The total number of tracks in the current folder of a data CD will be shown.

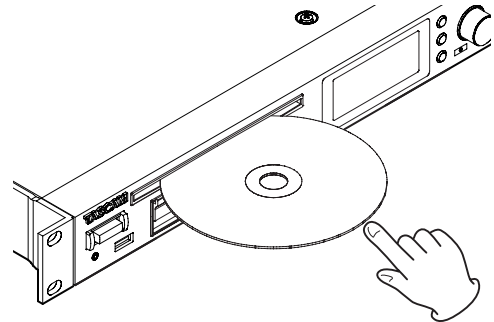

#### CAUTION

- Discs cannot be inserted when the power is OFF.
- Trying to force a disc in could damage the unit. If a disc becomes stuck partway, for example, and is difficult to push, do not try to force it in. Pull it out once, press the **EJECT** button and then try inserting it again.
- **MEDIA ERROR** will appear if discs other than audio CDs are inserted or discs are inserted upside-down. Press the **EJECT** button to eject such a disc.

#### NOTE

You can insert a disc anytime the power is ON, regardless of the current device setting.

### Ejecting discs

Press the **EJECT** button to eject a disc partially. Holding it by its sides, pull it out the rest of the way.

#### CAUTION

When the power is off, the **EJECT** button does not function.

### Selecting the device used

Before using the unit, select the device (USB, SD, CF or CD) for the type of media that you are using (choose CD for CD-R and CD-RW discs).

To select the device used, follow these procedures.

- 1 Press the **DEVICE** button (or remote control **DEVICE SELECT** button) to open the **DEVICE SELECT** screen.

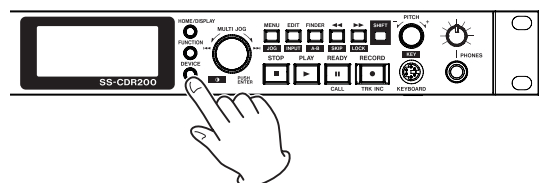

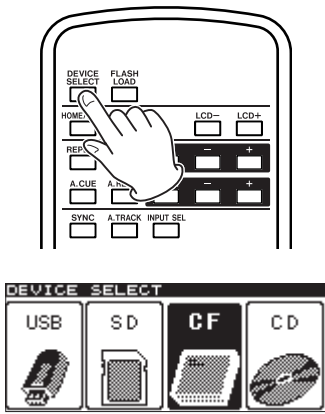

**NOTE**

The screen above is an example from an SS-CDR200. SS-R200 and SS-R100 models do not have the CD menu.

- 2 Press the **DEVICE** button (or remote control **DEVICE SELECT** button) to select the device to use, and press the **MULTI JOG** dial (or remote control **ENTER** button) to confirm.

**NOTE**

You can also turn the **MULTI JOG** dial to select the device.

- 3 The name of the selected device appears at the bottom right of the Home Screen.

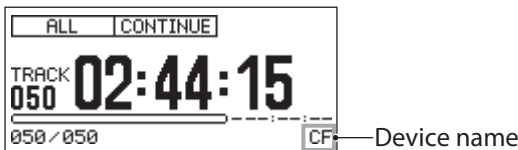

- USB: Select USB memory
- SD: Select SD card
- CF: Select CF card
- CD: Select CD with commercial audio CD (SS-CDR200 only)
- CDR: Select CD with CD-R (SS-CDR200 only)
- CDRW: Select CD with CD-RW (SS-CDR200 only)

## Preparing USB/SD/CF media for use

You must format USB/SD/CF media with this unit in order to make them usable by the unit.

**CAUTION**

- Formatting will erase all data on the USB/SD/CF media.
  - Always format with this unit. If USB/SD/CF media is formatted by another device or a computer, it could affect operation of the unit.
- 1 Press the **DEVICE** button (or remote control **DEVICE SELECT** button) to open the **DEVICE SELECT** screen, and select the device with the media that you want to format. (See “Selecting the device used” on page 26.)
  - 2 Press the **MENU [JOG]** button (or remote control **MENU** button) to open the **MENU** screen.

- 3 Open the **UTILITY** menu.
- 4 Select **MEMORY FORMAT**.

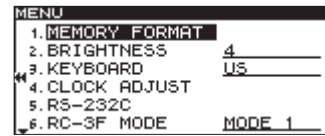

- 5 Press the **MULTI JOG** dial (or remote control **ENTER** button).

A confirmation pop-up message appears.



- 6 Press the **MULTI JOG** dial (or remote control **ENTER** button) again to start formatting.

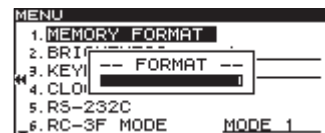

During formatting, **--FORMAT--** and a progress bar is displayed in a pop-up.

- 7 After formatting completes, the pop-up disappears and the **UTILITY** menu reopens.
- 8 Press the **HOME/DISPLAY** button (or remote control **HOME/DISP** button) to return to the Home Screen.

## Panel lock function

While pressing and holding the **SHIFT** button, press the **▶▶ [LOCK]** button to turn the panel lock function, which disables operation of the front panel buttons, ON and OFF. When panel lock is ON, using any front panel buttons (except the **SHIFT** and **▶▶ [LOCK]** buttons) or remote control buttons will cause a **--Key Lock--** and ON pop-up to appear.

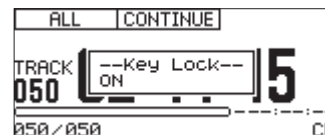

**NOTE**

Even when panel lock is ON, control is still possible when using a TASCAM RC-3F footswitch connected to the front panel **REMOTE JACK** or an external device connected to one of the rear panel **RS-232C**, **PARALLEL** or **REMOTE IN (RC-SS2) CONTROL I/O** connectors.

# 4 – Playback

This chapter explains the functions for playing audio files stored on CDs and USB/SD/CF media.

The following explanation assumes that a CD or USB/SD/CF media containing an audio file is inserted in the unit, that the unit is powered-on, and that the current device is selected appropriately (See “Selecting the device used” on page 26.)

## Files that can be played

These units are able to play files of the following formats.

### Files on USB/SD/CF media

#### MP3 format files

Stereo and mono MP3 files at 44.1 and 48 kHz sampling frequencies and 64–320 kbps bit rates

#### WAV format files

Stereo and mono WAV files at 44.1 and 48 kHz sampling frequencies

### Files on CDs (SS-CDR200 only)

#### Audio CD format files

Commercial music CDs, and CD-R and CD-RW discs created in audio CD format

#### MP3 format files

Stereo and mono MP3 files at 44.1 and 48 kHz sampling frequencies and 64–320 kbps bit rates

#### WAV format files

Stereo and mono WAV files at 44.1 and 48 kHz sampling frequencies

#### TIP

If a file is in one of the above formats, it can be played back regardless of whether or not it was recorded by this unit. For example, you can use a computer or other audio device to write a file that meets the above characteristics to a CD or USB/SD/CF media, and then load that media into this unit and play it back. In other words, you can efficiently prepare materials for playback on this unit.

#### CAUTION

Accurate position detection is not possible in MP3 files that have been compressed in VBR format due to limitations of that format. For this reason, when using functions that require points to be set in the middle of a track, including skipping backward or forward, calling and setting the A-B repeat A point, a discrepancy could occur between the point set and the point used when playback is started.

## Tracks and files

Audio data is saved on the media as “audio files.” These files are handled by the unit as “tracks.” When explaining recording and playback in this manual, we usually refer to audio files as “tracks.” We mainly use the term “files” when

explaining media management. Please be aware that these two terms actually refer to the same thing.

## Play area

The range of playback tracks that can be selected on the Home Screen is called the “play area.” For an audio CD, the play area will always be the entire disc. For CD-R/CD-RW discs and USB/SD/CF media that contain MP3 or WAV files, you can specify the play area.

If the media contains numerous files, limiting the play area will make it easier for you to select tracks.

## Setting the play area

Use the **PLAY AREA** item to set the play area.

- 1 Press the **MENU [JOG]** button (or remote control **MENU** button) to open the **MENU** screen.
- 2 Open the **PLAY** menu.
- 3 Select **PLAY AREA**.

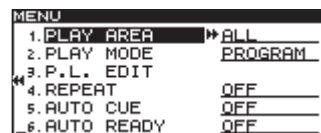

- 4 Press the **MULTI JOG** dial or **▶▶ [LOCK]** button (or remote control **ENTER** or **▶** button) to move the cursor to the right and select the setting item.
- 5 Turn the **MULTI JOG** dial (or press the remote control **▲ / ▼** buttons) to set the desired play area.  
ALL (default value): All files on the selected media  
FOLDER: All files in the selected folder  
PLAYLIST: All files added to the playlist  
When using USB/SD/CF media, all three of the above choices are possible.  
When using a data CD, the choices are **ALL** and **FOLDER**.  
When using an audio CD, this setting cannot be changed from **ALL**.
- 6 After making the setting, press the **HOME/DISPLAY** button (or remote control **HOME/DISP** button) to return to the Home Screen.

#### NOTE

- The current play area setting is shown at the top left of the Home Screen.



- The playback area setting is retained even after the power is turned OFF.

## Selecting the current folder or current playlist

If you have set the play area to be a folder or playlist (only when using USB/SD/CF media), you can select the applicable folder or playlist by using the ◀◀ [SKIP] and ▶▶ [LOCK] buttons (or remote control SEARCH ◀◀/▶▶ buttons) when the home screen is open and the unit is stopped. This folder or playlist is called the “current folder” or “current playlist.”

### NOTE

- You can also select the “current folder” or “current playlist” from the FINDER screen. (See “File and folder operations” on page 50.)
- When the audio files are MP3 or WAV format, a maximum of 999 tracks are playable by this unit. If media that contains more than 999 tracks is loaded into the unit, the 999 tracks selected according to the system rules will be playable. The remaining tracks cannot be played or edited.
- The SS-CDR200 is able to play CDs with a maximum of 99 CD audio format files.

## Playback modes

The tracks in the play area can be played using one of the following four playback modes.

### ■ Continuous playback mode (default setting)

[CONTINUE] appears in the playback mode indication area at the top of the Home Screen.

The tracks in the play area will play back in order of their track numbers.

### ■ Single playback mode

[SINGLE] appears in the playback mode indication area at the top of the Home Screen.

Only the currently selected track will play back, and then playback will stop.

### ■ Program playback mode

[PROGRAM] appears in the playback mode indication area at the top of the Home Screen.

The tracks will be played back in the order programmed in advance. (See “Program playback” on page 32.)

### ■ Random playback mode

[RANDOM] appears in the playback mode indication area at the top of the Home Screen.

All tracks in the play area will play back in random order without regard to their track numbers. When all tracks have been played back, playback will stop.

## Setting the playback mode

Use the front panel of the unit and the included TASCAM RC-SS2 remote control to set the desired playback mode using the following procedures.

### ■ Using the menu

- When stopped, press the MENU [JOG] button (or remote control MENU button) to open the MENU screen.
- Open the PLAY menu.
- Select PLAY MODE.

MENU	
1. PLAY AREA	ALL
2. PLAY MODE	▶▶ CONTINUE
3. P.L. EDIT	
4. REPEAT	OFF
5. AUTO CUE	OFF
6. AUTO READY	OFF

- Press the MULTI JOG dial or ▶▶ [LOCK] button (or remote control ENTER or ▶ button) to move the cursor to the right and select the setting item.
- Turn the MULTI JOG dial (or press the remote control ▲ / ▼ buttons) to set the desired playback mode.
- After making the setting, press the HOME/DISPLAY button (or remote control HOME/DISP button) to return to the Home Screen.

### NOTE

- In this manual, unless otherwise specified, explanations assume that the playback mode is set to CONTINUE (continuous playback mode).
- The playback mode setting is retained even after the power is turned OFF.

## Basic playback operations

This section explains basic operations including starting playback, playback standby and stopping.

The following explanation assume that you have completed the necessary connections, that the unit power is ON, the current device is set, media containing audio files is loaded in that device and the Home Screen is open.

### Playback

To start playback, press the **PLAY** button (or remote control **PLAY** button).

If no audio files that can be played back by this unit are on the media, the time display area will show all zeros.

#### To stop playback:

Press the **STOP** button.

#### To pause playback and enter playback standby:

Press the **READY** button.

## 4 – Preparations

In this manual, unless otherwise specified, explanations assume that the playback mode is set to **CONTINUE** (continuous playback mode).

### Selecting tracks

To select a track for playback, if the play area has more than one track, you can either skip to the previous or next track or enter a track number directly. Both methods are explained below.

### Skipping to the previous or next track

Turn the **MULTI JOG** dial (or press the remote control **SKIP** **I◀◀** and **▶▶I** buttons) to skip to the previous or next track.

- Turn the **MULTI JOG** dial right to skip to the next track or to the left to skip to the previous track.
- Press the remote control **SKIP** **▶▶I** button to skip to the next track or **I◀◀** button to skip to the previous track.

After selecting the track, press the front panel or remote control **PLAY** button to start track playback.

Alternatively, instead of pressing the front panel or remote control **PLAY** button, press the front panel or remote control **READY** button to start playback standby at the beginning of the selected track.

### Specifying a track number

You can use the remote's number buttons to directly enter the number of the track that you want to play.

For audio format CDs, the track number will be a maximum of two digits. For MP3 and WAV format media, the track number will be a maximum of three digits.

- 1 **Use the remote's number buttons to input the track number. Enter the track number starting with the highest digit.**

Example 1: For track 1, press **1**

Example 2: For track 12, press **1** followed by **2**

Example 3: For track 103 press **1** followed by **0** and then **3**

- 2 **Press the front panel or remote control PLAY button to start playback of the selected track.**

**Alternatively, instead of pressing the front panel or remote control PLAY button, press the front panel or remote control READY button to start playback standby at the beginning of the selected track.**

#### NOTE

- Instead of pressing the front panel or remote control **PLAY** button, you can also press the **MULTI JOG** dial or remote control **ENTER** button to start playback of the selected track.
- You cannot use the number buttons on the remote to specify the track while in program or random mode.

### Searching backward and forward

You can search forward or backward in a track while listening to the audio.

- 1 **Play the desired track or put it into playback standby.**
- 2 **Press and hold the ◀◀ [SKIP] or ▶▶ [LOCK] button (or remote control SEARCH ◀◀ or ▶▶ button) to start searching backward or forward.**
- 3 **To stop searching, release the button you are holding.**

The unit will return to the state (playback standby or playback) it was in before searching.

### Time search

When the unit is stopped, in playback standby or playing, you can locate to a specified time in the specified track.

#### NOTE

You cannot use time search when the play mode is **PROGRAM** or **RANDOM**.

Use the remote control number buttons to input numbers in the following order.

- Track number: 3 digits
- Elapsed time from the beginning of the track: two digits each hours, minutes, seconds

For example, if you want to specify a location that is 1 minute 30 seconds from the beginning of track 2, you would press keys in the following order.

**0 → 0 → 2 → 0 → 0 → 0 → 1 → 3 → 0**

When you finish entering the nine digits, the unit will automatically locate to the specified position.

If the unit was stopped or playing back before locating to the time, playback will begin after locating. If the unit was in playback standby prior to locating to the time, it will resume playback standby after locating.

If you specify a track number that does not exist in the current play area or a time that does not exist in the track, the operation will be cancelled at that point.

### Time searching after partial entry

If you press the remote's **ENTER**, **PLAY** or **READY** button before you finish entering the time, you will locate to the position that is specified at that point.

For example, suppose you intend to specify a location that is 12 minutes from the beginning of track 2, but do not complete the entry, inputting only:

**0 → 0 → 2 → 0 → 0 → 1 → 2**

Then, if you press the remote control **ENTER**, **PLAY** or **READY** button, the unit will locate to 12 minutes after the beginning of track 2. The button you push will determine what happens after locating.

**ENTER:** resumes playback or playback standby according to the status before locating

**PLAY:** starts playback

**READY:** enters playback standby

**NOTE**

- If you enter only the track number and press the **ENTER**, **PLAY** or **READY** button, the result is the same as described in “Specifying a track number” (page 31).
- You can also enter the numbers using a keyboard number pad.

## Jog playback

In jog playback mode, you can use the **MULTI JOG** dial on the main unit to search by one frame at a time.

- 1 While pressing and holding the **SHIFT** button, press the **MENU [JOG]** button to enable jog playback mode.

The **PLAY** and **READY** buttons flash, and the track elapsed time in the TRACK mode display on the Home Screen shows the frame value.

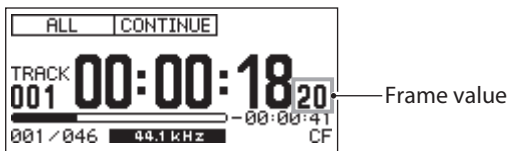

- 2 Turn the **MULTI JOG** dial to search.
- 3 To exit jog playback mode, press the **STOP**, **PLAY** or **READY [CALL]** button. The unit responds to the button pressed, stopping, playing back from or pausing at the searched position, accordingly.

**NOTE**

If the Home Screen display is in any mode other than TRACK mode, when using jog playback mode, the frame value will not be shown in the track elapsed time. Press the **HOME/DISPLAY** button (or remote control **HOME/DISP** button) to change to TRACK mode before starting jog playback mode.

## Skipping backward and forward

During playback and playback standby, you can skip backward or forward from the current position by the preset skip time.

During playback or when in playback standby, press the **◀◀ [SKIP]** or **▶▶ [LOCK]** button (or remote control **SEARCH ◀◀/▶▶** buttons) to locate backward or forward from the current position by the SKIP TIME. After locating, the previous state resumes.

**NOTE**

- If the time from the beginning of the track is less than the skip time when you press the **◀◀ [SKIP]** button (or remote control **SEARCH ◀◀** button), the unit will locate to the beginning of the current track.
- If the time from the beginning of the track is less than 1 second when you press the **◀◀ [SKIP]** button (or remote control **SEARCH ◀◀** button), the unit will locate to the position that is the skip time before the end in the previous track. However, if it is the first track of the current device media or program, playback standby will occur at the beginning of the current track.
- In random playback mode, if you press the **◀◀ [SKIP]** button (or remote control **SEARCH ◀◀** button) when the time from the beginning of the track is less than the skip time, the unit will always locate to the beginning of the current track.
- If the track remaining time is less than the skip time when you press the **▶▶ [LOCK]** button (or remote control **SEARCH ▶▶** button), the unit will locate to the beginning of the next track. However, if it is the last track of the current device media or program, playback standby will occur at the end of the current track.

## Setting the skip time

- 1 While pressing and holding the **SHIFT** button, press the **◀◀ [SKIP]** button to open a pop-up window where you can set the skip time.



- 2 Turn the **MULTI JOG** dial (or press the remote control **▲** and **▼** buttons) to set the skip time. **Setting values:** 1 sec - 60 sec (default value)
- 3 Press the **MULTI JOG** dial (or remote control **ENTER** button) to confirm setting values and return to the Home Screen.

## Call function

The call function returns to the call point (point from where playback last started from playback standby) and puts the unit in playback standby

When in playback standby, press the **READY [CALL]** button (or remote control **CALL** button) to return to the point from where playback last started and start playback standby.

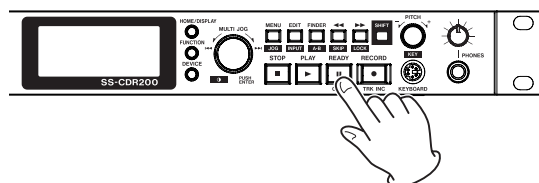

## 4 – Preparations

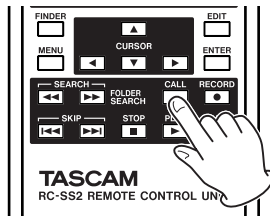

The call point will be erased when you perform any of the following operations.

- Turn the power OFF
- Remove media from the current device
- Change the play area
- Change the playback mode
- Modify the contents of the current device's media (by recording, editing or erasing, etc.).

### NOTE

- If you press the **READY [CALL]** button (or remote control **CALL** button) when a Call point has not been specified, a NoCallPoint pop-up message will appear.
- You cannot use the Call function in **PROGRAM** or **RANDOM** play modes.

## Program playback

By creating a program in advance, you can play the tracks you want in the order you desire. The program can have a maximum of 99 tracks.

### Preparing the program

Use the front panel of the unit and the included TASCAM RC-SS2 remote control to prepare the program using the following procedures.

- 1 When stopped, set the playback mode to PROGRAM.** (See “Setting the playback mode” on page 32.)
- 2 Turn the MULTI JOG dial (or use remote control number buttons) to input the number of the track that you want to program, and press the dial (or remote control ENTER button) to add the track to the program.**
- 3 Repeat step 2 to add other tracks to the program in order.**  
The screen shows the program number and total time.
- 4 Press the front panel or remote control PLAY button to start program playback.**

### NOTE

- You can add the same track to the program repeatedly.
- Pressing the **EDIT [INPUT]** button (or remote control **EDIT** button) will remove the last added track from the program.
- A maximum of 99 tracks can be programmed. If you attempt to program a 100th track, a **PROGRAM FULL** warning message pop-up will appear.

- If the total time of the programmed tracks exceeds 99 hours 59 minutes, 59 seconds, “-- --:--:--” will appear on the display.
- In **PROGRAM** play mode, playback is not possible unless at least one track is added to the program.
- When stopped, all program data will be cleared if you press the front panel or remote control **STOP** button.
- Program data will be cleared if you switch the play mode.
- Program data will be cleared when you power-off the unit.

## Pitch control playback

Using pitch control playback, this unit can modify the pitch (the pitch and playback speed) of the playback.

Follow these procedures to use pitch control playback.

- 1 Push the PITCH knob (or remote control PITCH button) to turn the pitch control function ON.**

When ON, the **PITCH** indicator appears on the Home Screen.



- 2 Turn the PITCH knob (or press the remote control PITCH +/- buttons) to set the pitch level.**

While adjusting the pitch control value, it is shown in a pop-up on the Home Screen.

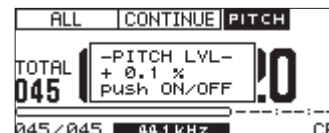

The pitch level can be set in a range from -16.0% - +16.0%.

### To turn off pitch control playback:

Press the front panel **PITCH** knob (or remote control **PITCH** button).

The **PITCH** indicator on the Home Screen disappears when the pitch control function is OFF.

### NOTE

- When you turn pitch control playback ON/OFF during playback, the playback sound may be momentarily interrupted.
- The pitch level setting made in step 2 above is retained even when the pitch control function is OFF, and it will be used the next time the function is turned ON again.

### TIP

By using the key control function together with the pitch control function, you can change only the speed without affecting the pitch. (See “Key control playback” in the following section.)



## Setting the pitch step

You can change the pitch step (amount of pitch adjustment).

The pitch step is the amount of pitch change produced by turning the **PITCH** knob one step or by pressing the Remote's **PITCH +/-** button once.

- 1 **Press and hold the PITCH knob (or remote control PITCH button) to open the -PITCH STEP- and X.X% pop-up on the Home Screen.**



- 2 **While the PITCH STEP pop-up is shown, turn the MULTI JOG dial to set the pitch step.**

Setting range: 0.1% (default value) – 1.0%

- 3 **After making the setting, push the PITCH knob (or remote control PITCH button) to return to the Home Screen.**

### NOTE

The pitch step setting is retained even after the power is turned OFF.

## Key control playback

Using the key control function, you can change the playback key (pitch in semitones).

Follow these procedures in menu mode to turn key control ON/OFF and set the key level.

- 1 **While pressing and holding the SHIFT button, press the PITCH knob (or press the remote control KEY button) to turn the key control function ON.**

When ON, the **KEY** indicator appears on the Home Screen.



- 2 **While pressing and holding the SHIFT button, turn the PITCH knob (or press the remote control KEY - and + buttons) to set the KEY LEVEL.**

While adjusting the **KEY LEVEL**, it is shown in a pop-up on the Home Screen.



You can set the **KEY LEVEL** in a range from  $b_6$ - $b_1$ , 0 (no pitch change), #1-#6.

### NOTE

- When using the key control function, the playback may sound irregular. This is due to the special processing being applied to the playback signal, and is not a malfunction.
- The key control **KEY LEVEL** setting is retained even after the power is turned OFF.

### TIP

If you turn on both the key control and pitch control functions, the key (pitch) will be determined by the key control setting and the speed will be determined by the pitch control setting. (In other words, using pitch control to change the speed will not affect the pitch of the sound). Thus, if you set **KEY LEVEL** to 0 and turn key control ON, you can use pitch control to change the playback speed without affecting the pitch.

## Repeat playback

You can repeatedly play back all tracks in the play area, or repeatedly play back a specified region within a track (A-B Repeat playback).

### Ordinary repeat playback

When the repeat playback function is ON, the following will occur according to the playback mode.

- **CONTINUE**: the entire play area will be played back repeatedly
- **SINGLE**: the current track will be played back repeatedly
- **PROGRAM**: the entire program will be played back repeatedly
- **RANDOM**: the entire play area will be played back at random

To turn the repeat playback function ON, follow one of these procedures.

## 4 – Preparations

### ■ Using the menu

- 1 Press the MENU [JOG] button (or remote control MENU button) to open the MENU screen.
- 2 Open the PLAY menu.
- 3 Select REPEAT.

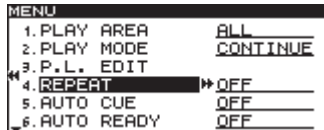

- 4 Press the MULTI JOG dial or ►► [LOCK] button (or remote control ENTER or ► button) to move the cursor to the right and select the setting item.
- 5 Turn the MULTI JOG dial, (or press the remote control ▲ and ▼ buttons) to set it to ON (default value: OFF).
- 6 Press the HOME/DISPLAY button (or remote control HOME/DISP button) to return to the Home Screen.

### ■ Using the dedicated remote control button

- 1 Press the remote control REPEAT button to set --Repeat-- to ON. A pop-up appears showing that repeat playback is ON.



- 2 Press the remote control FUNC button to open the FUNCTION screen, and check that REPEAT is highlighted.

### ■ Turning repeat playback OFF

Use the PLAY menu REPEAT item or press the remote control REPEAT button to turn it OFF.

The REPEAT indicator on the FUNCTION screen appears unhighlighted when OFF.

#### NOTE

The repeat playback setting is retained even after the power is turned OFF.

### A-B repeat playback

This lets you specify a desired region (A-B) within a track to be played back repeatedly. Follow these procedures to conduct A-B repeat playback.

- 1 During playback or when in playback standby, at the position where you want to start repeat playback, press the FINDER [A-B] button while pressing and holding the SHIFT button (or remote control A-B button) to set the starting point (A). --Repeat-- and A-B appear in a pop-up on the Home Screen.



#### NOTE

If you press the remote control REPEAT button, the repeat playback starting point (A) will be cancelled.

- 2 Once again press the FINDER [A-B] button while pressing and holding the SHIFT button (or remote control A-B button) to set the ending point (B) of the repeat playback interval.

--Repeat-- and A-B appear in a pop-up on the Home Screen.



This completes setting the interval (A-B), and A-B repeat playback will start.

#### NOTE

- During playback if you press the remote control REPEAT or A-B button, Repeat and OFF appear in a pop-up, A-B repeat playback is cancelled, and playback will continue even after the designated ending point (B) is reached.
- If you press the front panel or remote control STOP button to stop playback, the designated interval (A-B) is cleared.
- The A-B repeat playback interval cannot span more than one track.

## Auto Cue function

If the Auto Cue function is on, and you select a track to play, any "silent" portion at the beginning of the track will be skipped, and the track will be put into playback standby at the point where its "signal" begins to be audible. This means that sound will be heard immediately when you start playback.

#### NOTE

- When using the flash start function to start playback, Auto Cue function is disabled.
- When the Auto Cue function is on, if a track is selected during playback, playback will start from the point where it becomes audible. If a track is selected when in playback standby, playback standby will start at the point where it becomes audible.
- The Auto Cue function setting is retained even after the power is turned OFF.

You can specify the threshold level (Auto Cue LEVEL) used to detect the audio signal when the Auto Cue function is active. In other words, any signal higher than the Auto Cue LEVEL will be treated as "signal," and any signal lower than this level will be treated as "silence."

## ■ Using the menu

- 1 When stopped, press the MENU [JOG] button (or remote control MENU button) to open the MENU screen.
- 2 Open the PLAY menu.
- 3 Select AUTO CUE.

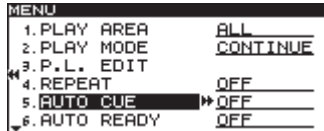

- 4 Press the MULTI JOG dial or ►► [LOCK] button (or remote control ENTER or ► button) to move the cursor to the right and select the setting item.
- 5 Turn the MULTI JOG dial (or press the remote control ▲/▼ buttons) to set it to ON (default value: OFF).
- 6 Press the MULTI JOG dial or ►► [LOCK] button (or remote control ENTER or ► button) to open the AUTO CUE setting screen.

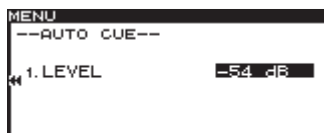

Set the Auto Cue level on this screen.

- 7 Turn the MULTI JOG dial (or press the remote control ▲/▼ buttons) to set the desired Auto Cue LEVEL.  
Setting range: -24 dB --72 dB (6 dB intervals, default value: -54 dB)
- 8 When you have finished making the setting, press the HOME/DISPLAY button (or remote control HOME/DISP button) to return to the Home Screen.

## ■ Using the dedicated remote control button

- 1 Press the remote control A.CUE button to turn the Auto Cue function ON and open a pop-up showing --Auto cue-- and ON.



- 2 Press the remote control FUNC button to open the FUNCTION screen, and check that AUTO CUE is highlighted.

## Auto Ready function

If the Auto Ready function is ON, when a track finishes playing, playback standby will occur at the beginning of the next track.

### NOTE

- If the Auto Cue function is ON, playback standby will occur when sound starts in the next track rather than at the beginning of track.
- When starting playback with the flash start function, the Auto Ready function is disabled.
- The Auto Ready function setting is retained even after the power is turned OFF.

## ■ Using the menu

- 1 Press the MENU [JOG] button (or remote control MENU button) to open the MENU screen.
- 2 Open the PLAY menu.
- 3 Select AUTO READY.



- 4 Press the MULTI JOG dial or ►► [LOCK] button (or remote control ENTER or ► button) to move the cursor to the right and select the setting item.
- 5 Turn the MULTI JOG dial (or press the remote control ▲ and ▼ buttons) to set it to ON (default value: OFF).
- 6 When you have finished making the setting, press the HOME/DISPLAY button (or remote control HOME/DISP button) to return to the Home Screen.

## ■ Using the dedicated remote control button

- 1 Press the remote control A.READY button to turn the Auto ready function ON and open a pop-up showing --Auto ready-- and ON.



- 2 Press the remote control FUNC button to open the FUNCTION screen, and check that AUTO READY is highlighted.

## 4 – Preparations

### Incremental playback function

When the incremental playback function is ON, press the front panel or remote control **PLAY** button during playback to start playback from the beginning of the next track, or press the front panel or remote control **STOP** button to start playback standby at the beginning of the next track.

#### NOTE

- When the incremental playback function is ON, pressing the front panel or remote control **PLAY** button when in playback standby will start playback from that position. When in playback standby, pressing the front panel or remote control **STOP** button will stop playback.
- When the last track is playing back, pressing the front panel or remote control **PLAY** button will start playback of the first track in the play area. Pressing the **STOP** key will pause at the beginning of the first track in the play area.
- The incremental playback function setting is retained even after the power is turned OFF.

- 1 Press the **MENU [JOG] button** (or remote control **MENU button**) to open the **MENU** screen.
- 2 Open the **PLAY** menu.
- 3 Select **INC. PLAY**.



- 4 Press the **MULTI JOG dial** or **▶▶ [LOCK] button** (or remote control **ENTER** or **▶ button**) to move the cursor to the right and select the setting item.
- 5 Turn the **MULTI JOG dial** (or press the remote control **▲** and **▼** buttons) to set it to **ON** (default value: OFF).
- 6 When you have finished making the setting, press the **HOME/DISPLAY button** (or remote control **HOME/DISP button**) to return to the Home Screen.

### Mono playback

You can play back a stereo audio file in mono. In this case, the left and right signals of the track will be mixed to mono and the same mono signal will be output from both the L and R outputs.

Use the menu to make this setting.

- 1 Press the **MENU [JOG] button** (or remote control **MENU button**) to open the **MENU** screen.
- 2 Open the **PLAY** menu.
- 3 Select **OTHERS**.
- 4 Press the **MULTI JOG dial** or **▶▶ [LOCK] button** (or remote control **ENTER** or **▶ button**) to open the **PLAY OTHERS** menu.

- 5 Select **MONO MIX**.



- 6 Press the **MULTI JOG dial** or **▶▶ [LOCK] button** (or remote control **ENTER** or **▶ button**) to move the cursor to the right and select the setting item.
- 7 Turn the **MULTI JOG dial** (or press the remote control **▲** and **▼** buttons) to set it to **ON** (default value: OFF).
- 8 When you have finished making the setting, press the **HOME/DISPLAY button** (or remote control **HOME/DISP button**) to return to the Home Screen.

#### NOTE

The **MONO MIX** setting is retained even after the power is turned OFF.

### EOM functions (SS-CDR200/SS-R200 only)

By turning EOM functions ON, you can set the unit to output EOM tally signals from the **CONTROL I/O PARALLEL** connector when the track or play area remaining time becomes less than the set time.

#### Setting EOM tally output triggers

Use the menu mode to set the track and play area remaining times that will trigger EOM tally signal output.

- 1 Press the **MENU [JOG] button** (or remote control **MENU button**) to open the **MENU** screen.
- 2 Open the **PLAY** menu.
- 3 Select **OTHERS**.
- 4 Press the **MULTI JOG dial** or **▶▶ [LOCK] button** (or remote control **ENTER** or **▶ button**) to open the **PLAY OTHERS** menu.
- 5 Select **EOM TRACK** if you want to set the track remaining time as a trigger or **EOM MEDIA** if you want to set the remaining time in the play area as the trigger.



- 6 Press the **MULTI JOG dial** or **▶▶ [LOCK] button** (or remote control **ENTER** or **▶ button**) to move the cursor to the right and select the setting item.
- 7 Turn the **MULTI JOG dial** (or press the remote control **▲** and **▼** buttons) to set the remaining time for the trigger.

EOM TRACK options:

OFF (default value), 0s – 99s (seconds)

EOM MEDIA options:

OFF (default value), 1s – 99s (seconds)

**NOTE**

If EOM TRACK is set to 0s, when the track ends a pulse of about 100 ms will be output.

- 8 When you have finished making the setting, press the HOME/DISPLAY button (or remote control HOME/DISP button) to return to the Home Screen.

**NOTE**

The EOM function setting is retained even after the power is turned OFF.

### Example of use

- 1 Connect the device that will receive the EOM tally signal to the CONTROL I/O PARALLEL connector.
- 2 Turn the power ON for both this unit and the receiving device.
- 3 Begin playback.

When the remaining time of the current track or the play area falls below the specified time, an EOM tally signal will be output from the CONTROL I/O PARALLEL connector.

If the remaining time of both the track and the play area have been set as triggers, an EOM tally signal will be transmitted when either condition is satisfied.

### Resume playback

If the Resume Playback function is on, playback will begin at the “resume point,” which is the location where playback was last stopped.

The Resume point will be erased if you do any of the following.

- Remove the media from the current device
- Change the play area.
- Change the play mode
- Modify the contents of the media in the current device (by recording, editing, or erasing)

Use the menu to turn the RESUME function ON/OFF.

- 1 Press the MENU [JOG] button (or remote control MENU button) to open the MENU screen.
- 2 Open the PLAY menu.
- 3 Select OTHERS.
- 4 Press the MULTI JOG dial or ►► [LOCK] button (or remote control ENTER or ► button) to open the PLAY OTHERS menu.
- 5 Select RESUME.



- 6 Press the MULTI JOG dial or ►► [LOCK] button (or remote control ENTER or ► button) to move the cursor to the right and select the setting item.
- 7 Turn the MULTI JOG dial (or press the remote control ▲ and ▼ buttons) to set it to ON (default value: OFF).
- 8 When you have finished making the setting, press the HOME/DISPLAY button (or remote control HOME/DISP button) to return to the Home Screen.

**NOTE**

- If no playable track exists (e.g., if not even one track has been registered in PROGRAM mode), the display will show all zeros.
- If the resume point does not exist (i.e., if the time registered as the resume point does not exist), the beginning of the first track in the play area will become the resume point.
- The RESUME playback function setting is retained even after the power is turned OFF.

## 4 – Preparations

### Using power-on play

By using a commercially-available timer, for example, to start power to the unit, you can start playback at the desired time.

- 1 Connect the SS-unit to a timer so that its power will be supplied from the timer's power output.
- 2 Load media for playback in the current device and set the play area and playback mode, for example, as necessary.
- 3 Press the MENU [JOG] button (or remote control MENU button) to open the MENU screen.
- 4 Open the PLAY menu.
- 5 Select OTHERS.
- 6 Press the MULTI JOG dial or ►► [LOCK] button (or remote control ENTER or ► button) to open the PLAY OTHERS menu.
- 7 Select POWER ON PLAY.



- 8 Press the MULTI JOG dial or ►► [LOCK] button (or remote control ENTER or ► button) to move the cursor to the right and select the setting item.
- 9 Turn the MULTI JOG dial (or press the remote control ▲ and ▼ buttons) to set it to ON (default value: OFF).
- 10 Press the HOME/DISPLAY button (or remote control HOME/DISP button) to return to the Home Screen.
- 11 Set the timer to the desired time.  
When the set time arrives, the unit will be powered-on, and playback will begin automatically.

#### NOTE

- When power-on play is enabled, the **POP** indicator appears on the Home Screen.
- The POWER ON PLAY setting is retained even after the power is turned OFF.

### Link playback function

By using the link function, you can make a slave unit follow the playback operations of the master unit.

You can use the slave for playback backup.

Play, ready, stop, track skip and search operations are conveyed by the link. However, synchronization of operations is not guaranteed with this function.

In order to minimize the delay between units, use identical media with identical contents from the same maker in both master and slave units. Furthermore, you should also set the units so that they have the same playback settings (including Auto Cue and Auto Ready functions) and flash load statuses.

Since there is no clock synchronization, the playback time might become slightly out of sync after playback for a long time.

When using the link function, the digital inputs and outputs cannot be used.

### Link playback connections

Connect the master DIGITAL OUT jack to the slave DIGITAL IN jack.

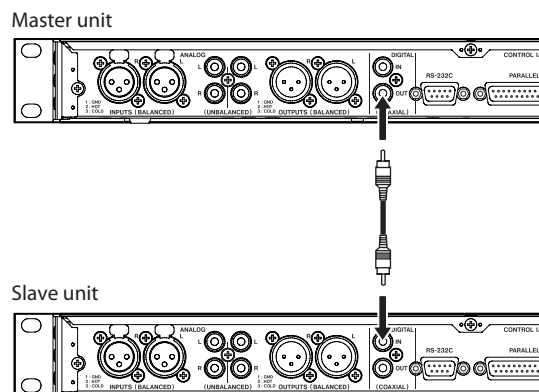

### Setting link playback

- 1 Press the MENU [JOG] button (or remote control MENU button) to open the MENU screen.
- 2 Open the PLAY menu.
- 3 Select OTHERS.
- 4 Press the MULTI JOG dial or ►► [LOCK] button (or remote control ENTER or ► button) to open the PLAY OTHERS menu.
- 5 Select LINK.



- 6 Press the MULTI JOG dial or ►► [LOCK] button (or remote control ENTER or ► button) to move the cursor to the right and select the setting item.

7 Turn the **MULTI JOG** dial (or press the remote control **▲** and **▼** buttons) to set it to **MASTER** or **SLAVE** as appropriate.

Options: **OFF** (default value), **MASTER**, **SLAVE**

8 When you have finished making the setting, press the **HOME/DISPLAY** button (or remote control **HOME/DISP** button) to return to the Home Screen.

### NOTE

The **LINK** playback setting is retained even after the power is turned OFF.

## Flash start function

Using the flash start function, you can instantly start playback of tracks that you have registered in advance.

The beginnings of up to twenty tracks can be pre-loaded into memory, so that playback can be triggered instantly by a PS/2 or USB keyboard connected to the front panel, or by an external device connected to the parallel connector on the rear panel (SS-CDR200/SS-R200 only) as well as by a TASCAM RC-20 Direct Play Remote (sold separately).

- 1 **Set the play area.** (See “Play area” on page 28.)  
Set the play area as the playlist or folder that contains the tracks you want to flash-start. Make sure that there are no more than twenty tracks.
- 2 **Set the playback mode to **CONTINUE** or **PROGRAM**.** (See “Playback modes” on page 29.)

### NOTE

You cannot use Flash Load if the play mode is set to **RANDOM**.

- 3 **When stopped, press the remote control **FLASH LOAD** button.**

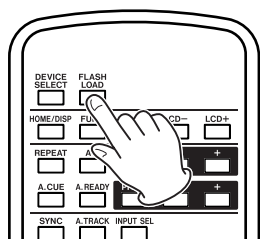

The unit will successively read the beginning of each track in the play area.

The tracks will be read in the order of playback. In other words if the play mode is **CONTINUE**, the tracks will be read consecutively, starting with the first. If the play mode is **PROGRAM**, the tracks will be read in the order of the program.

While the tracks are being read, the **P** indicator on the home screen will blink.

When the tracks have all been loaded, the **P** indicator will stop blinking and stay visible.



### NOTE

- If the playback mode is set to **RANDOM** and you press the remote control **FLASH LOAD** button, a **CAN'T SELECT** warning message pop-up will appear, and the data will not be read.
- If the playback mode is set to **SINGLE** and you press the remote control **FLASH LOAD** button, the tracks in the play area will be read successively in the same way as for the **CONTINUE** setting.
- If twenty-one or more tracks are registered, data for the first twenty tracks from the beginning will be loaded.

- 4 **When **FLASH** appears on the Home Screen, you can trigger flash-start playback from a PS/2 or USB keyboard connected to the front panel or from an external device connected to the parallel connector (SS-CDR200/SS-R200 only).**

If you are using a PS/2 or USB keyboard, you can press **CTRL** and a function key (**F1–F12**) to flash-start tracks 1–12 (see “Keyboard operation list” on page 74.).

If you are using the external parallel connector, you will be able to flash-start tracks 1–20 (See “Using the parallel connector” on page 76.)

### NOTE

Tracks to be flash started must have the same sampling frequencies. If a track with a different sampling frequency is detected while loading the tracks, **-- error --** and **FLASH LOAD** appear on the display, and the unit will cancel track loading.

### TIP

By setting the play area to **PLAYLIST** and selecting a playlist that contains only the tracks that you want to flash-start as the current playlist, you can efficiently use the flash start setting for the desired tracks (see “Play area” on page 28 and “Editing the playlist (USB/SD/CF media only)” on page 60).

# 5 – Recording

These models can record to USB memory and SD and CF cards. The SS-CDR200 can also record to CD-R and CD-RW discs. The following formats can be used for audio recording.

## USB/SD/CF media:



MP3 and WAV (44.1/48 kHz sampling frequency) format audio files

## CD-R/CD-RW discs:

MP3 (44.1/48 kHz sampling frequency) and CD format audio files

The following explanations assume that you have loaded recordable USB/SD/CF media or a CD-R/CD-RW disc (SS-CDR200 only), completed the necessary connections and turned the unit's power ON.

### NOTE

- If the current device is set to , an unfinalized CD-R or CD-RW disc must be inserted.
- The maximum number of recordable tracks is 999 tracks for a USB memory, SD card, or CF card (total number of MP3 tracks and WAV tracks) on the SS-CDR200/SS-R200/SS-R100. In the case of a CD-R/CD-RW disc, a data CD disc containing MP3 files can have up to 999 tracks, and an audio CD disc can have up to 99 tracks on the SS-CDR200.
- When using media with a capacity of 2 GB or less, 999 tracks cannot be recorded into the root folder due to file system limitations. A maximum of 999 tracks can be recorded into subfolders.
- If a write-protected SD card is loaded in the unit, the  icon appears on the Home Screen and recording will not be possible. (See "SD card write protection" on page 26.)
- You can also copy or convert and copy audio files between a CD and USB/SD/CF media. For details, see "Copying files between CDs and other media (SS-CDR200 only)" on page 63.
- You cannot record in WAV format onto a CD-R/CD-RW disc. However, you can copy WAV files from USB/SD/CF media to a CD-R/CD-RW disc, and play back WAV files on a data CD. (See "Creating data CDs" on page 65.)

## Automatic protection against unintentional power interruptions

If an unintentional power interruption occurs when recording to USB/SD/CF media, the protection function prevents complete loss of track recording data. Data up to 25 seconds before the interruption is saved.

### CAUTION

- Although there is a protection function, due to the nature of USB/SD/CF media, if the unit is writing to the system area when the power is interrupted or the USB/SD/CF media is removed from the unit, all the files on the memory/card could be damaged or lost. For this

reason, you should try as much as possible to avoid power interruptions during recording and playback.

- This function was not created for the purpose of use with an external timer, for example, turning off the power.

## Selecting the input source

Set the input source (recording source) to one of three types of input (analog balanced, analog unbalanced, digital).

Follow the procedures below to select the input source.

### NOTE

- You cannot change the input source when recording.
- The input source selection is retained even after the power is turned OFF.

## Selecting the source from the front panel

While pressing and holding the **SHIFT** button, press the **EDIT [INPUT]** button to show the current input. Press again when this is shown to switch between input sources.

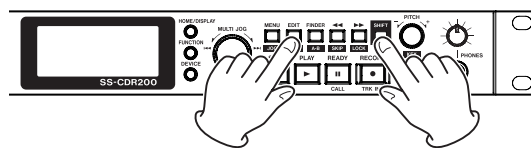

## Selecting the source from the remote control

Press the **INPUT SEL** button on the TASCAM RC-SS2 remote control to show the current input. Press again when this is shown to switch between input sources.

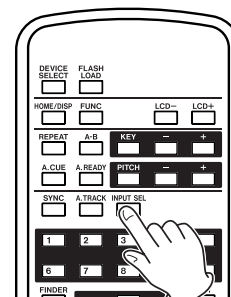

## Show the input source

While pressing and holding the **SHIFT** button, press the **EDIT [INPUT]** button to show the currently selected input source.

### A.BAL. (SS-CDR200/SS-R200 only)

Signals from **ANALOG INPUTS L/R (BALANCED)** jacks

### A.UNBAL.

Signals from **ANALOG INPUTS L/R (UNBALANCED)** jacks

### D.COAX.

Signals from **DIGITAL IN (COAXIAL)** jacks



**NOTE**

When the input source setting is **D. COAX**, you cannot start recording from recording standby in the following situations.

- When the unit is not digitally locked to the input source (**DIN UNLOCK** will appear on the display).
- When the input source is not audio (**DIN NotAudio** will appear on the display).
- When the sampling frequency specified by the **REC** menu **REC FORMAT** item differs from the input source. (**FS UNMATCH** will appear on the display). However if you have enabled the sampling rate converter, recording can take place even if the sampling frequency is different (see “Using the sampling rate converter” on page 41).

## Setting the recording file format

If the current device is set to **USB**, **SD** or **CF**, the unit can record in **MP3** and **WAV** formats. If the current device is set to **CD**, the unit can record in **MP3** and audio **CD** formats (**SS-CDR200** only).

Moreover, both **MP3** and **WAV** files can be on the same **USB** memory or **SD/CF** card, but both **MP3** and audio **CD** format files cannot be included on the same **CD-R** or **CD-RW** disc. The first file recorded on the **CD-R** or **CD-RW** disc will determine the file format that can be recorded on that disc (**MP3** or audio **CD**).

**NOTE**

- **WAV** files cannot be recorded to a **CD-R/CD-RW** disc, but using the file copy function described below, you can copy **WAV** files from **USB/SD/CF** media to **CD-R/CD-RW** discs (**SS-CDR200** only). (See “Copying files between **CDs** and other media” on page 63.)
- Recording of **MP3** files to **CD-R/CD-RW** discs is possible only if a blank disc is inserted. If you eject the disc or turn off the power, adding recordings later will not be possible. (See “Finalizing **CD-R/CD-RW** discs (**SS-CDR200** only)” on page 43.)

When stopped or in recording standby, use the menu to set the file format.

- 1 Press the **MENU [JOG]** button (or remote control **MENU** button) to open the **MENU** screen.
- 2 Open the **REC** menu.
- 3 Select **REC FORMAT**.

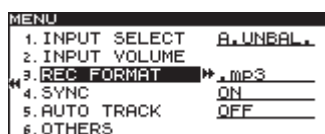

- 4 Press the **MULTI JOG** dial or **▶▶ [LOCK]** button (or remote control **ENTER** or **▶** button) to move the cursor right to select the value.

- 5 Turn the **MULTI JOG** dial (or press the remote control **▲** and **▼** buttons) to select the recording file format.

**USB/SD/CF media:** **.mp3** (default value), **.wav**

**CD-R/CD-RW disc (SS-CDR200 only):** **.mp3** (default value), **CDDA** (audio **CD** format)

If the current device is set to **CD** and the recording file format is set to **CDDA**, steps 6 and 7 below are not necessary (no screen appears). Skip to step 8.

If the current device is set to **USB**, **SD** or **CF** and the recording file format is set to **CD** or **.mp3**, continue with the following procedures.

- 6 Press the **MULTI JOG** dial or **▶▶ [LOCK]** button (or remote control **ENTER** or **▶** button) to open the **REC FORMAT** screen.

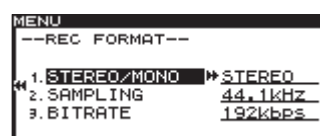

- 7 Set the following items on the **REC FORMAT** screen.

**STEREO/MONO**

Set whether the recording file should be a stereo file or a mono file.

Options: **STEREO** (default value), **MONO**

**SAMPLING**

Set the sampling frequency.

Options: **44.1kHz** (default value), **48kHz**

**BITRATE (can only be set when the recording file format is set to .mp3)**

Set the bit rate.

Options: **64kbps**, **128kbps**, **192kbps** (default value), **256kbps**, **320kbps**

The bit rate option is the value when recording in stereo. When set to mono recording, the bit rate will be halved, resulting in the same sound quality.

- 8 When you have finished making the setting, press the **HOME/DISPLAY** button (or remote control **HOME/DISP** button) to return to the Home Screen.

**NOTE**

The recording file format setting is retained even after the power is turned OFF.

## Using the sampling rate converter

Since this unit has a built-in sampling rate converter, you can record at a sampling frequency that is different from the sampling frequency of the digital input source.

Use the menu to turn the sampling rate converter (**SRC**) **ON/OFF**.

- 1 Press the **MENU [JOG]** button (or remote control **MENU** button) to open the **MENU** screen.
- 2 Open the **REC** menu.

## 5 – Recording

- 3 Select OTHERS.
- 4 Press the MULTI JOG dial or ►► [LOCK] button (or remote control ENTER or ► button) to open the REC OTHERS screen.
- 5 Select SRC.

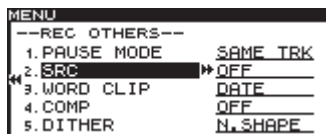

- 6 Press the MULTI JOG dial or ►► [LOCK] button (or remote control ENTER or ► button) to move the cursor right to select the value.
- 7 Turn the MULTI JOG dial (or press the remote control ▲ and ▼ buttons) to set it to ON (default value: OFF).
- 8 When you have finished making the setting, press the HOME/DISPLAY button (or remote control HOME/DISP button) to return to the Home Screen.

### NOTE

- If a digital signal with a sampling frequency that differs from the sampling frequency specified in the REC FORMAT item is being received at the DIGITAL IN jack, and you attempt to record with SRC off, an FS UNMATCH error message will appear.
- The sampling rate converter (SRC) setting is retained even after the power is turned OFF.

## Monitoring the input signal

When you press the front panel or remote control **RECORD** button to enter recording standby, the **RECORD** and **READY** buttons light, and the input signal will be output from the various output jacks (headphones, analog balanced, analog unbalanced and digital). In addition, the meters on the home screen will show the input level.

To end recording standby, press the front panel or remote control **STOP** button.

### TIP

- If you simply want to monitor the input signal without intending to record anything, press the **RECORD** key without any media in the current device. **MONITOR** will appear on the display, and the **RECORD** button will blink red.
- To stop monitoring the input signal, press the **STOP** button on the front panel or remote control.

## Adjusting the input signal level and balance

You can use the menu to adjust the level and balance of the input signal.

Follow the instructions in the “Monitoring the input signal” section above to enable monitoring of the input signal, and then follow these procedures.

- 1 Press the MENU [JOG] button (or remote control MENU button) to open the MENU screen.
- 2 Open the REC menu.
- 3 Select INPUT VOLUME.

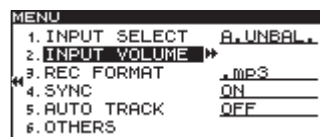

- 4 Press the MULTI JOG dial or ►► [LOCK] button (or remote control ENTER or ► button) to open a pop-up with the INPUT VOLUME settings.

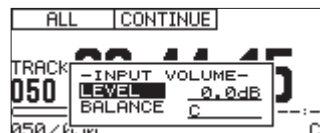

- 5 Set the following INPUT VOLUME items.

### LEVEL

Adjust the input level.

Options: -inf, -54dB - 0.0dB (default value) - +18dB

### BALANCE

Adjust the input balance.

Options: L50 - C (center, default value) - R50

### NOTE

- The level meter will show OVER at -0.2 dBfs.
  - Since the level meter appears on the Home Screen at the top of the display, you can check the input level as you adjust it. Set the level as high as possible without making the OVER indicator to the right of the meter appear.
- 6 When you have finished making the setting, press the HOME/DISPLAY button (or remote control HOME/DISP button) to return to the Home Screen.

### NOTE

The input LEVEL and BALANCE settings are retained even after the power is turned OFF.

## Basic recording operations

You can begin recording after you have finished making the above settings (input source selection, recording file format setting, sampling rate converter ON/OFF, input level adjustment).

### To start recording standby from a stopped state:

Press the front panel or remote control **RECORD** button to put the unit in recording standby (The **RECORD** and **READY** buttons light).

### To start recording from recording standby:

Press the front panel or remote control **PLAY** button.

### To switch from recording to recording standby:

Press the front panel or remote control **READY** button.

## To stop recording:

Press the front panel or remote control **STOP** button. When you stop recording, the recorded data will be written and an audio file will be created.

### NOTE

- You can use the **WORD CLIP** item in the **REC OTHERS** menu to set the audio file name that is automatically added to files when they are created. (See “Setting the format for naming recorded files” on page 47.)
- The maximum size of each track is 2 GB.
- The recorded track will be created in the current folder. (See “Folder operations” on page 51.)

### CAUTION

While the recorded content is being written to the recording media, **INFORMATION WRITING** will appear the display. While this message is shown, do not move the unit, turn off the power or remove the media from the current device. The recorded content will not be able to be saved correctly if you do so.

## Finalizing CD-R/CD-RW discs (SS-CDR200 only)

After you have recorded to a CD-R or CD-RW disc, you will need to finalize the disc before the disc can be played back by a CD player or CD drive other than this unit. The finalization procedures using this unit depend on whether the file format is MP3 or audio CD.

### With MP3 format recordings:

The unit will automatically finalize the CD-R/CD-RW disc when you eject it. This means that once you remove a disc that was recorded in MP3 format, you will not be able to add recordings to that disc. In addition, if you turn off the power without ejecting the CD-R/CD-RW disc, the unit will automatically finalize the disc the next time it is powered-on.

You can also use the menu to finalize the disc without ejecting it. (See “Finalizing discs” below.)

### With audio CD format recordings:

If you have recorded in audio CD format, the unit will not automatically finalize the disc. You will be able to make additional recordings on that disc (as long as there is free space remaining on the disc) until you finalize the disc using the menu. However, the disc will not be playable on other devices until you finalize it. For details on how to finalize, refer to the following section.

## Finalizing discs

As explained above, in order for a CD-R/CD-RW disc recorded by the unit in audio CD format to be playable on another device, that CD must be finalized manually. Moreover, although discs recorded in MP3 format will be finalized automatically when ejected, as described above, you can also finalize a disc manually without ejecting it.

In either case, follow these procedures to finalize a disc.

- 1 Press the **DEVICE** button (or remote control **DEVICE SELECT** button) to open the **DEVICE SELECT** screen, and select **CD**. (See “Selecting the device used” on page 26.)
- 2 Press the **MENU [JOG]** button (or remote control **MENU** button) to open the **MENU** screen.
- 3 Open the **CD** menu.
- 4 Select **FINALIZE**.

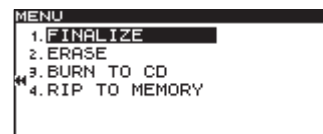

- 5 Press the **MULTI JOG** dial or **▶▶ [LOCK]** button (or remote control **ENTER** button or **▶** button).

A confirmation pop-up message appears.



- 6 Press the **MULTI JOG** dial or **▶▶ [LOCK]** button (or remote control **ENTER** button or **▶** button) again to start finalization.

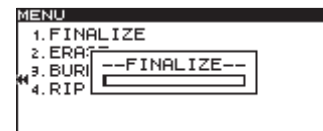

-- FINALIZE -- and a progress bar are displayed in a pop-up during finalization.

When finalization is completed, the **CD** menu will reopen.

### NOTE

You can unfinalize a finalized CD-RW disc. (See “Unfinalizing CD-RW discs” on page 69.)

## Sync recording

If the sync recording function is ON, recording will begin automatically when the input signal exceeds the level set in advance (**SYNC LEVEL**). After recording has begun, if the input signal stays below the sync level for the specified length of time (**STOP TIME**), the unit will end recording and switch to recording standby automatically.

### Sync settings

Use the menu to turn the sync recording function ON/OFF and to make detailed settings. You can also use the remote’s **SYNC** key to turn this function ON/OFF.

When the sync recording function is on, **SYNC REC** will appear highlighted on the **FUNCTION** screen.

# 5 – Recording

## ■ Using the menu

- 1 Press the **MENU [JOG] button** (or remote control **MENU button**) to open the **MENU** screen.
- 2 Open the **REC** menu.
- 3 Select **SYNC**.

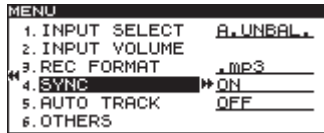

- 4 Press the **MULTI JOG dial** or **▶▶ [LOCK] button** (or remote control **ENTER** or **▶ button**) to move the cursor right to select the value.
- 5 Turn the **MULTI JOG dial** (or press the remote control **▲** and **▼** buttons) to turn the sync recording function **ON** (default value: **OFF**).
- 6 Press the **MULTI JOG dial** or **▶▶ [LOCK] button** (or remote control **ENTER** or **▶ button**) to open the **SYNC** setting screen.

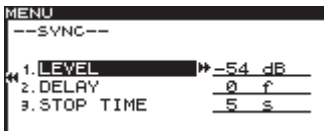

- 7 Set the following items on the **SYNC** setting screen.

### LEVEL

Sets the sync level.

Options: -72 dB – -24 dB (default value: -54 dB)

### DELAY

Sets the time (in frames) from when a signal exceeding the sync level is detected until recording begins (one frame is 1/75th of a second).

Options: -75f – +75f (frames, default value: 0f)

If set to a negative value, that amount of audio prior to triggering will also be captured.

### STOP TIME

Sets the time that the signal must be below the **SYNC LEVEL** until recording stops and recording standby resumes.

Options: INF (∞), 5s – 30s (default value: 5s)

### NOTE

When the **DELAY** setting range is converted to seconds, it is equivalent to ±1.00 seconds.

- 8 When you have finished making the setting, press the **HOME/DISPLAY button** (or remote control **HOME/DISP button**) to return to the Home Screen.

### NOTE

The sync recording setting is retained even after the power is turned OFF.

## ■ Using the remote control SYNC button

Push the remote control **SYNC** button to open the **SYNC** pop-up window in the Home Screen and turn the function **ON/OFF**.

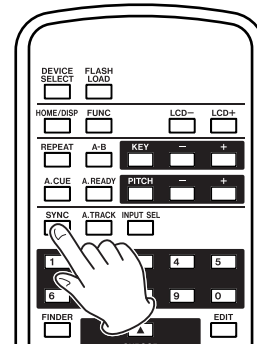

## Sync recording operation

When the sync recording function is **ON** and the unit is in recording standby, recording will automatically start or stop according to the level of the input source.

- When a signal higher than the sync level is input, recording will begin automatically. However, recording will not begin even if input is detected unless there has been at least one second in which the signal was below **SYNC LEVEL** after entering recording standby.

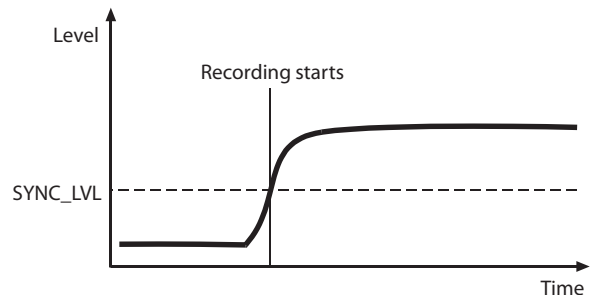

### NOTE

The above explanation is for the case when the **DELAY** setting is 0f (default value). By changing the **DELAY** setting, you can change the point when recording starts.

- When recording, if the input signal stays below the sync level for the **STOP TIME**, the unit will automatically switch to the recording standby.

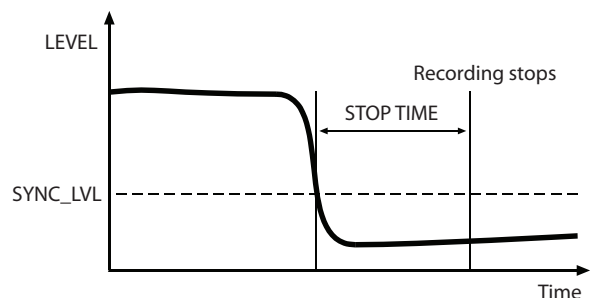

### NOTE

If the **STOP TIME** is set to **INF**, recording standby will not be entered automatically even if the input signal stays below the **SYNC LEVEL**.

- To stop sync recording, use the REC menu SYNC item or push the remote control SYNC button to set SYNC to OFF.

## ■ If the sync level is too high

If the sync level setting is too high, you may have problems such as failing to capture the beginning of a song that begins with a low volume.

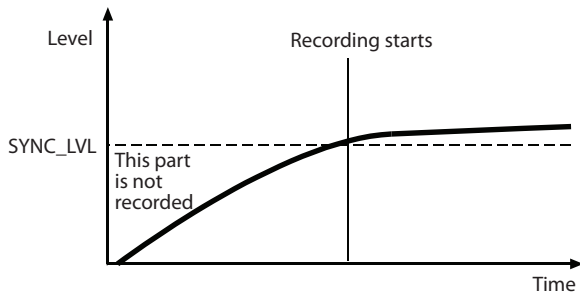

## ■ If the sync level is too low

Sync recording will not begin from recording standby, if the source you are recording has a high noise level.

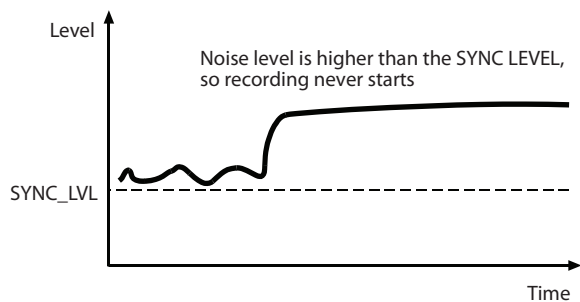

## Auto Track function

Auto Track recording is a function that automatically creates a new track with a new number when a set condition is met during recording.

Use the menu to enable Auto Track mode and make detailed settings. In addition, Auto Track mode can also be turned ON/OFF using the remote control **A.TRACK** button.

When the Auto Track function in ON, **AUTO TRACK** will appear highlighted on the **FUNCTION** screen.

Auto Track settings can be changed at any time, so you can change settings while recording.

### NOTE

If you have recorded in WAV format, you can also use editing functions to divide or join tracks after recording. (See "Dividing files" on page 57 and "Combining files" on page 58.)

## ■ Using the menu

- Press the **MENU [JOG]** button (or remote control **MENU** button) to open the **MENU** screen.
- Open the **REC** menu.
- Select **AUTO TRACK**.

MENU		
1. INPUT SELECT	A.UNBAL.	
2. INPUT VOLUME		
3. REC FORMAT	MP3	
4. SYNC	ON	
5. <b>AUTO TRACK</b>	OFF	
6. OTHERS		

- Press the **MULTI JOG** dial or **▶▶ [LOCK]** button (or remote control **ENTER** or **▶** button) to move the cursor right to select the value.
- Turn the **MULTI JOG** dial (or push remote control **▲** and **▼** buttons) to select one of the following Auto Track modes.

### OFF (default value)

New tracks will not be created automatically.

### LEVEL

A new track will be created when the signal exceeds the auto track level (**AUTO TRACK** screen **LEVEL** value) after having stayed below it for two seconds or longer.

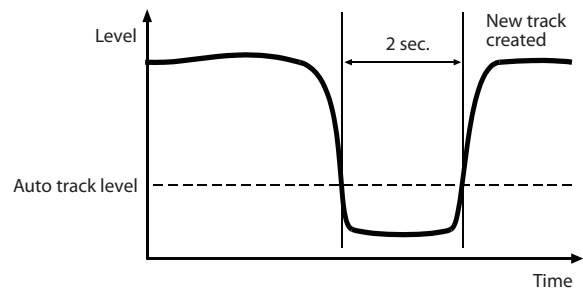

### DD

When recording a digital source (CD, DAT, MD) via the **DIGITAL IN** jack, a new track will be created when a track division is detected in the source.

However when recording an analog source or a digital source other than those listed above, this will work in the same way as **LEVEL** mode, and new tracks will be created in response to the input level.

### TIME

A new track will be created at the set time interval (**AUTO TRACK** screen **INTERVAL** value).

- If you set **AUTO TRACK** to anything other than **OFF**, press the **▶▶ [LOCK]** button (or remote control **▶** button) to open the **AUTO TRACK** setting screen for the current mode.
- Set the following items according to the mode.

### LEVEL mode

- LEVEL**  
Sets the level that triggers the Auto Track function.  
Options: -72 dB – -24 dB (6dB steps, default value: -54 dB)
- DELAY**  
Sets the time (in frames) from when a signal exceeding the **LEVEL** is detected until a new track is created (one frame is 1/75th of a second).  
Options: -75 f – +75 f (frame, default value: 0f)

## 5 – Recording

If set to a negative value, that amount of audio prior to triggering will also be included in the new track.



### NOTE

When the setting range is converted to seconds, it is equivalent to  $\pm 1.00$  seconds.

### DD (digital direct) mode

#### . DELAY

Sets the time in frames until a new track is started from a point detected in DD mode (one frame is = 1/75 seconds).

Options: -75 f – +75 f (frame)  
(default value: 0 f)



### TIME mode

#### . INTERVAL

Sets the frequency of new track creation.

Options: 1 min – 10min, 5 min, 30min,  
1 hour, 2 hour, 6 hour, 8 hour, 12hour,  
24hour (default value: 5 min)

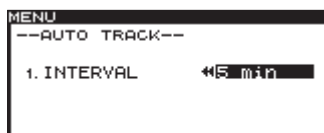

**8** When you have finished making the setting, press the **HOME/DISPLAY** button (or remote control **HOME/DISP** button) to return to the Home Screen.

### NOTE

The Auto Track function setting is retained even after the power is turned OFF.

### ■ Using the remote control to change the Auto Track mode

Press the remote control **A.TRACK** button to open the Auto Track pop-up window on the Home Screen, and change the Auto Track mode.

Pressing the buttons cycles through the modes in this order: OFF → LEVEL → DD → TIME → OFF.

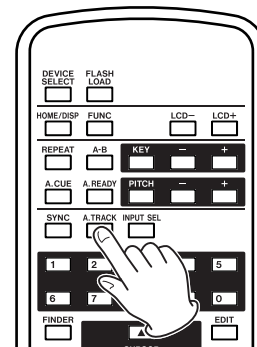

## Creating a new track manually

When recording, press the front panel or remote control **RECORD** button, to create a new track (with a higher number) without interrupting recording.

You cannot, however, create a track of 4 seconds or less.

### NOTE

If you have recorded in WAV format, you can also use editing functions to divide or join tracks after recording. (See “Dividing files” on page 57 and “Combining files” on page 58.)

### CAUTION

Depending on the USB/SD/CF media used in the unit, when recording in MP3 format, creating many tracks in a short time period can cause recording to stop. An **OVER FLOW** error message will appear on the screen when this occurs.

To avoid this, wait some time between uses of this function.

## Setting the pause mode

Set whether or not a new track is created when switching from recording to recording standby.

- 1 Press the **MENU [JOG]** button (or remote control **MENU** button) to open the **MENU** screen.
- 2 Open the **REC** menu.
- 3 Select **OTHERS**.
- 4 Press the **MULTI JOG** dial or **▶▶ [LOCK]** button (or remote control **ENTER** or **▶** button) to open the **REC OTHERS** screen.
- 5 Select **PAUSE MODE**.

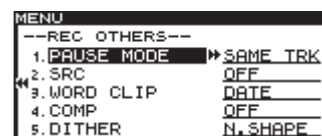

- 6 Press the **MULTI JOG** dial or **▶▶ [LOCK]** button (or remote control **ENTER** or **▶** button) to move the cursor right to select the value.

- Turn the **MULTI JOG** dial (or push remote control **▲** and **▼** buttons) to select one of the following pause modes.

### SAME TRK (default value)

No new track created when switching from recording to recording standby

### NEW TRAK

New track created when switching from recording to recording standby.

- When you have finished making the setting, press the **HOME/DISPLAY** button (or remote control **HOME/DISP** button) to return to the Home Screen.

#### NOTE

- This setting cannot be changed when recording or in recording standby.
- The pause mode setting is retained even after the power is turned OFF.

## Using the compressor when recording

You can apply the built-in compressor to the recording source while you record.

A compressor is an effect that lowers the level of loud peaks and raises the level of quiet parts in the audio, making the overall level more consistent and quieter recorded sounds easier to hear.

Use the menu to turn the compressor ON/OFF.

- Press the **MENU [JOG]** button (or remote control **MENU** button) to open the **MENU** screen.
- Open the **REC** menu.
- Select **OTHERS**.
- Press the **MULTI JOG** dial or **▶▶ [LOCK]** button (or remote control **ENTER** or **▶** button) to open the **REC OTHERS** screen.
- Select **COMP**.

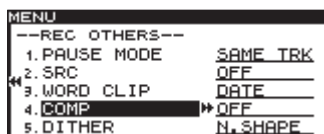

- Press the **MULTI JOG** dial or **▶▶ [LOCK]** button (or remote control **ENTER** or **▶** button) to move the cursor right to select the value.
- Turn the **MULTI JOG** dial (or push remote control **▲** and **▼** buttons) to select one of the following compressor modes.

### OFF (default value)

The compressor is not used when recording.

### SOFT

Light compression is applied when recording. This setting is suitable when recording music.

### HARD

Strong compression is applied. When the audio source being recorded has a low volume, the recording volume will be boosted significantly, making it suitable when recording a meeting or conference.

- When you have finished making the setting, press the **HOME/DISPLAY** button (or remote control **HOME/DISP** button) to return to the Home Screen.

#### NOTE

The compressor setting is retained even after the power is turned OFF.

## Setting the format for naming recorded files (MP3/WAV files only)

You can specify the file name that is automatically given to files when recorded. Use the menu to make this setting.

- Press the **MENU [JOG]** button (or remote control **MENU** button) to open the **MENU** screen.
- Open the **REC** menu.
- Select **OTHERS**.
- Press the **MULTI JOG** dial or **▶▶ [LOCK]** button (or remote control **ENTER** or **▶** button) to open the **REC OTHERS** screen.
- Select **WORD CLIP**.

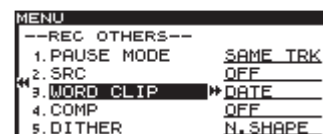

- Press the **MULTI JOG** dial or **▶▶ [LOCK]** button (or remote control **ENTER** or **▶** button) to move the cursor right to select the value.
- Turn the **MULTI JOG** dial (or push remote control **▲** and **▼** buttons) to select one of the following file name formats.

### DATE (default value)

The date of the built-in clock will become the file name.

### USER 01 – USER 03

A user-set text string (eight characters) will be used as the file name.

- If you selected one of the user options (**USER 01 – USER 03**), press the **MULTI JOG** dial or **▶▶ [LOCK]** button (or remote control **ENTER** or **▶** button) to open the **WORD CLIP** screen where you can edit the name.

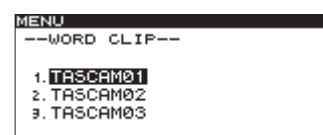

- To edit the file name, follow the instructions in "Inputting and editing characters" below.

## 5 – Recording

**10** When you have finished editing the name, press the **MULTI JOG** dial (or remote control **ENTER** button) to confirm the changes to the string of characters.

**11** When you have finished making the setting, press the **HOME/DISPLAY** button (or remote control **HOME/DISP** button) to return to the Home Screen.

### NOTE

The recording file name (**WORD CLIP**) settings are retained even after the power is turned OFF.

### Inputting and editing characters

Use the following operations to edit the characters.

#### To change the editing location (cursor position):

Use the **◀◀ [SKIP]** and **▶▶ [LOCK]** buttons (or remote control **◀** and **▶** buttons).

#### To change the character at the cursor position:

Turn the **MULTI JOG** dial (or push the remote control **▲/▼** buttons).

#### To insert a space:

While pressing and holding the **SHIFT** button, press the **▶▶ [LOCK]** button (or remote control **SEARCH ▶▶** button).

#### To delete a character:

While pressing and holding the **SHIFT** button, press the **◀◀ [SKIP]** button (or remote control **SEARCH (◀◀** button).

#### To delete all characters left of the cursor position:

While pressing and holding the **SHIFT** button, press and hold the **◀◀ [SKIP]** button (or remote control **SEARCH ◀◀** button).

#### To switch between uppercase and lowercase:

Press the **EDIT [INPUT]** button (or remote control **EDIT** button).

#### To cancel editing:

Press the **MENU [JOG]** button (or remote control **MENU** button).

### CAUTION

- You can also directly access USB/SD/CF media from a computer to change the names of files, but doing so could change the previous playback order of the files.
- Names that contain characters other than the letters of the alphabet, numbers and symbols cannot be edited (the name will not appear when the **RENAME** function is being used).
- The following symbols and punctuation marks cannot be used in names.
- \ / ; : \* , ? " < > |

## Recording with dither

When recording 16-bit WAV files, the 16-bit format limits the dynamic range to approximately 96.3 dB.

You can set how quiet sounds that are lost below the 17th bit (quantization noise) are processed when recording

- 1 Press the **MENU [JOG]** button (or remote control **MENU** button) to open the **MENU** screen.
- 2 Open the **REC** menu.
- 3 Select **OTHERS**.
- 4 Press the **MULTI JOG** dial or **▶▶ [LOCK]** button (or remote control **ENTER** or **▶** button) to open the **REC OTHERS** screen.
- 5 Select **DITHER**.



- 6 Press the **MULTI JOG** dial or **▶▶ [LOCK]** button (or remote control **ENTER** or **▶** button) to move the cursor right to select the value.
- 7 Turn the **MULTI JOG** dial (or push remote control **◀** and **▶** buttons) to select one of the following dither settings.

#### OFF (default value)

No dithering is used. The recording is 16-bit and anything outside this range (16th bit and smaller) is cut.

#### DITHER

White noise half the size of the minimum bit (16th bit) is added, creating a modulation between the 16th and 17th bits, which suppresses quantization noise.

#### N.SHAPE

Primary noise shaping is used. The quantization noise itself is fed back and shaped. This suppresses the quantization noise, expanding the dynamic range.

- 8 When you have finished making the setting, press the **HOME/DISPLAY** button (or remote control **HOME/DISP** button) to return to the Home Screen.

### NOTE

The dither setting is retained even after the power is turned OFF.



## Media capacities and recording times

This table shows maximum total recording times for different media capacities and file formats.

File format (recording setting)			USB/SD/CF media (hours:minutes)				CD-R/CD-RW media (hours:minutes)
			1 GB	2 GB	4 GB	8 GB	700 MB
WAV (stereo)	44.1 kHz		1:36	3:12	6:24	12:48	----
	48 kHz		1:28	2:56	5:52	11:44	----
WAV (mono)	44.1 kHz		3:12	6:24	12:48	25:36	----
	48 kHz		2:56	5:52	11:44	23:28	----
MP3 (stereo)	64 kbps	44.1 kHz/48 kHz	35:20	70:40	141:20	282:40	24:50
	128 kbps	44.1 kHz/48 kHz	17:40	35:20	70:40	141:20	12:25
	192 kbps	44.1 kHz/48 kHz	11:40	23:20	46:40	93:20	8:15
	256 kbps	44.1 kHz/48 kHz	8:50	17:40	35:20	70:40	6:10
	320 kbps	44.1 kHz/48 kHz	7:00	14:00	28:00	56:00	4:55
MP3 (mono)	64 kbps	44.1 kHz/48 kHz	70:40	141:20	282:40	565:20	49:40
	128 kbps	44.1 kHz/48 kHz	35:20	70:40	141:20	282:40	24:50
	192 kbps	44.1 kHz/48 kHz	23:20	46:40	93:20	186:40	16:30
	256 kbps	44.1 kHz/48 kHz	17:40	35:20	70:40	141:20	12:25
	320 kbps	44.1 kHz/48 kHz	14:00	28:00	56:00	112:00	9:55
CD-DA	44.1 kHz		---	---	---	---	1:20

- The above recording times are estimates. They may differ depending on the USB/SD/CF media being used.
- The above recording times are not continuous recording times. They are the total amounts of recordable time on the USB/SD/CF media.

# 6 – File and folder operations (FINDER screen)

You can manage audio files on USB/SD/CF media in a folder structure. You can also manage MP3/WAV files on a data CD in a folder structure (SS-CDR200 only).

You can select a folder or file and then enter the **FINDER** screen for that file and folder.

When working with USB/SD/CF media, on the **FINDER** screen, you can create folders, edit the names of folders and files, delete folders and files and add files to the playlist, for example. You can also perform operations directly in the **FINDER** screen to move and copy files between folders.

When working with an unfinalized data CD that has recorded MP3 or WAV files, the only operations that can be performed from the **FINDER** screen are creating folders and changing the current folder. You cannot edit or add files to a playlist.

In the case of a CD that contains audio CD format files, the audio CD **FINDER** screen will open. (See “Opening the audio CD **FINDER** screen” on page 56.)

## TIP

By using a card reader or other interface to read files on USB/SD/CF media from a computer, you will be able to use your computer to modify the folder structure, edit folder and file names, and delete folders and files. If you perform this type of editing from your computer, be aware that the playback order of the files on the unit may have changed.

## Opening the FINDER screen

The following operations assume that USB/SD/CF media, a data CD containing MP3/WAV files or a blank CD is loaded and the current device is set accordingly.

When the play area (see “Play area” on page 28) is set to **ALL** or **FOLDER** and the unit is stopped, playing, or paused, you can press the **FINDER [A-B]** button (or remote control **FINDER** button) to open the **FINDER** screen.

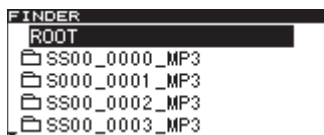

- If the play area is set to **ALL** when stopped, the root folder **FINDER** screen opens.
- If the play area is set to **FOLDER** when stopped, the current folder **FINDER** screen opens.
- When in playback standby, regardless of the play area setting, the **FINDER** screen for the folder that contains the currently selected file opens and the current file is highlighted.

## NOTE

The currently selected item appears as light letters on a dark background.

## Navigating the FINDER screen

The **FINDER** screen shows folders and music files in each folder as a list that is similar to a computer file list display.

When the **FINDER** screen is open, use the **MULTI JOG** dial and **◀◀ [SKIP]/ ▶▶ [LOCK]** buttons (or remote control **▲/▼/◀/▶** buttons) to select folders and files for use.

- Press the **MULTI JOG** dial (or remote control **ENTER** button) to open the **FINDER MENU** pop-up for that file or folder. (See “File operations” on page 51 and “Folder operations” on page 51.)
- When a folder is selected, press the **▶▶ [LOCK]** button (or remote control **▶** button) to show the contents of the folder.
- Press the **FINDER [A-B]** button (or remote control **FINDER** button) to go back to the previous item.
- When a file or folder is selected, press the **◀◀ [SKIP]** button (or remote control **◀** button) to move up one level in the folder structure.
- When a file or folder is selected, press the **HOME/ DISPLAY** button (or remote control **HOME/DISP** button) to return to the Home Screen.
- When a file or folder is selected, press the front panel or remote control **PLAY** button to return to the Home Screen and play that file or folder. If the play area is set to **FOLDER**, the selected folder becomes the current folder.
- When a file or folder is selected, press the **READY [CALL]** button (or remote control **READY** button) to return to the Home Screen and put that file or folder into playback standby. If the play area is set to **FOLDER**, the selected folder becomes the current folder.
- When a file or folder is selected, press the **EDIT [INPUT]** button (or remote control **EDIT** button) to open the Edit Menu pop-up.
- When a file or folder is selected (shown as light text on a dark background), press the **SHIFT** button to scroll its name across the display.

## Icons on the FINDER screen

The icons that appear on the **FINDER** screen have the following meanings.

### Current folder (■)

This is the currently selected folder.

### Folder (📁)

These are folders other than the currently selected folder.

### Audio file (🎵)

The names of music files appear next to these icons.

## 6 – File and folder operations (FINDER screen)

### File operations

Select the desired audio file on the **FINDER** screen, and press the **MULTI JOG** dial (or remote control **ENTER** button) to open the file **FINDER MENU** pop-up.

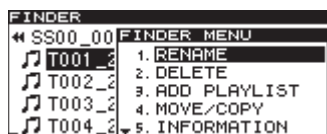

Turn the **MULTI JOG** dial (or push remote control **▲/▼** buttons) to select the desired item and press the **MULTI JOG** dial (or remote control **ENTER** button) to execute one of the following operations.

#### NOTE

If a write-protected SD card is loaded, the **RENAME**, **DELETE**, **ADD PLAYLIST** and **MOVE/COPY** items cannot be used. (See “SD card write protection” on page 26.)

#### RENAME

This opens the **RENAME** screen where you can edit the selected file name. (See “Editing file names (USB/SD/CF media)” on page 52.)

#### DELETE

Deleted the selected item. (See “Deleting folders and files (USB/SD/CF media)” on page 53.)

#### ADD PLAYLIST

Add the selected file to the desired playlist. (See “Adding files to a playlist (USB/SD/CF media)” on page 53.)

#### MOVE/COPY

Move the selected file to a different position in the same folder or move or copy it to another folder. (See “Moving and copying files (USB/SD/CF media)” on page 54.)

#### INFORMATION

Show information, including the file format and sampling frequency, about the selected file in a pop-up.



#### CANCEL

Cancel any operation with the selected file, close the **FINDER MENU** and return to the **FINDER** screen.

### Folder operations

Select the desired folder on the **FINDER** screen, and press the **MULTI JOG** dial (or remote control **ENTER** button) to open the folder **FINDER MENU** pop-up.

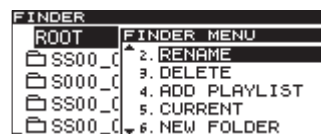

Turn the **MULTI JOG** dial (or push remote control **▲/▼** buttons) to select the desired item, and press the **MULTI JOG** dial (or remote control **ENTER** button) to execute one of the following operations.

#### NOTE

- All the **FINDER MENU** functions can be used with USB/SD/CF media. Only some of the functions can be used with (unfinalized) data CDs with MP3/WAV files.
- If a write-protected SD card is loaded, the **RENAME**, **DELETE**, **ADD PLAYLIST** and **MOVE/COPY** items cannot be used. (See “SD card write protection” on page 26.)

#### SELECT

Open the selected folder.

#### RENAME

This opens the **RENAME** screen where you can edit the selected folder name. (See “Editing folder names (USB/SD/CF media)” on page 52.)

#### DELETE (USB/SD/CF media)

Deleted the selected item. (See “Deleting folders and files (USB/SD/CF media only)” on page 53.)

#### ADD PLAYLIST

Add the entire selected folder to the desired playlist. (See “Adding entire folders to a playlist (USB/SD/CF media)” on page 53.)

#### CURRENT

A pop-up message that allows you to set the selected folder as the current folder appears.

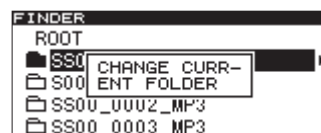

#### NOTE

Audio files created during recording will be added to the current folder. If you create a new folder to store new recordings, follow the procedures above to set it as the current folder.

#### NEW FOLDER

Creates a new folder. (See “Creating a new folder” on page 54.)

#### MOVE/COPY

Move the selected file to a different position in the same folder or move or copy it to another folder. (See “Moving and copying files (USB/SD/CF media)” on page 54.)

## 6 – File and folder operations (FINDER screen)

### INFORMATION

Show information, including the total number of files and total time, about the selected folder in a pop-up.



### CANCEL

Cancel any operation with the selected folder, close the FINDER MENU and return to the FINDER screen.

### Editing folder names (USB/SD/CF media only)

- 1 Select the folder that you want to edit, and turn the MULTI JOG dial (or push remote control ▲/▼ buttons) to select **RENAME**.
- 2 Press the MULTI JOG dial (or remote control ENTER button) to open the **RENAME** screen.

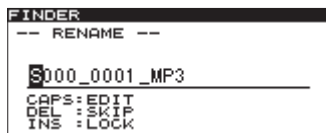

- 3 Edit the folder name. Follow the instructions in “Inputting and editing characters” on page 48.
- 4 When you have completed editing the folder name, press the MULTI JOG dial (or remote control ENTER button) to confirm the change.

-- RENAME -- and a progress bar appear in a pop-up while the folder name is being changed.

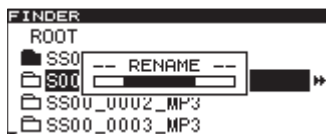

After the folder name has been changed, the FINDER screen reopens.

### NOTE

- Names that contain characters other than the letters of the alphabet, numbers and symbols cannot be edited (the name will not appear when the **RENAME** function is being used).
- The following symbols and punctuation marks cannot be used in names.

\\/:\*,?<>|

### Editing file names (USB/SD/CF media only)

- 1 Select the file that you want to edit, and turn the MULTI JOG dial (or push remote control ▲/▼ buttons) to select **RENAME**.
- 2 Press the MULTI JOG dial (or remote control ENTER button) to open the **RENAME** screen.



- 3 Edit the file name. Follow the instructions in “Inputting and editing characters” on page 48.
- 4 When you have completed editing the file name, press the MULTI JOG dial (or remote control ENTER button) to confirm the change.

-- RENAME -- and a progress bar appear in a pop-up while the file name is being changed.

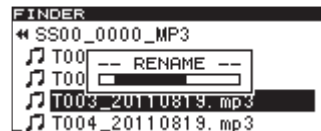

After the file name has been changed, the FINDER screen reopens.

### NOTE

- You can also directly access USB/SD/CF media from a computer to change the names of files, but doing so could change the previous playback order of the files.
- Names that contain characters other than the letters of the alphabet, numbers and symbols cannot be edited (the name will not appear when the **RENAME** function is being used).
- The following symbols and punctuation marks cannot be used in names.

\\/:\*,?<>|

## 6 – File and folder operations (FINDER screen)

### Deleting folders and files (USB/SD/CF media only)

You can delete folders and files from USB/SD/CF media. If you delete a folder, all the files in it will also be deleted. This function can only be used when the playback mode is set to CONTINUE.

- 1 Select the folder or file that you want to delete, and turn the MULTI JOG dial (or press the remote control **▲** and **▼** buttons) to select **DELETE**.

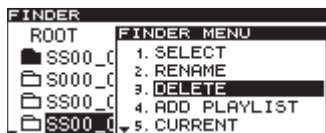

- 2 Press the MULTI JOG dial (or remote control **ENTER** button).

A confirmation pop-up message appears.



To cancel deletion, press the FINDER [A-B] button (remote control FINDER button).

- 3 Press the MULTI JOG dial (or remote control **ENTER** button) to delete the item from the USB/SD/CF media.

-- ERASE -- and a progress bar appear in a pop-up while the item is being deleted.



After deletion completes, the FINDER screen reopens.

#### NOTE

Immediately after deleting a folder or file, you can undo the operation. (See "Undoing EDIT menu operations" on page 59.)

### Adding entire folders to a playlist (USB/SD/CF media only)

You can add all the files in a folder to the desired playlist at once.

Files in subfolders, however, will not be added.

- 1 Select the folder that you want to add to the playlist, open the FINDER screen, and turn the MULTI JOG dial (or push remote control **▲**/**▼** buttons) to select **ADD PLAYLIST**.

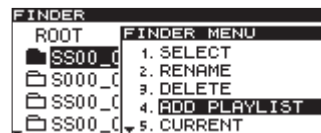

- 2 Press the MULTI JOG dial (or remote control **ENTER** button) to open the **ADD PLAYLIST** screen.



- 3 Turn the MULTI JOG dial (or push remote control **▲**/**▼** buttons) to select the destination playlist.

- 4 Press the MULTI JOG dial or **▶▶** [LOCK] button (or remote control **ENTER** or **▶** button) to open the selected playlist.



- 5 Turn the MULTI JOG dial (or push remote control **▲**/**▼** buttons) to set the location of the folder that you are adding in the playlist. The inserted folder will appear highlighted, and its files will be inserted at that position.

- 6 Press the MULTI JOG dial (or remote control **ENTER** button) to add the folder contents to the playlist.

-- PLAYLIST -- and **ADD** appear in a pop-up and the file (or all files in the folder) are added to the playlist.



#### NOTE

- A maximum of 99 tracks can be added to a playlist.
- If you attempt to add more than 99 tracks, a **F.LIST FULL** warning message pop-up will appear, and the track(s) will not be added.
- You cannot add the same track more than once to a playlist.

### Adding files to a playlist (USB/SD/CF media only)

You can add files to the desired playlist.

- 1 Select the file that you want to add to the playlist, open the FINDER screen, and turn the MULTI JOG dial (or push remote control **▲**/**▼** buttons) to select **ADD PLAYLIST**.

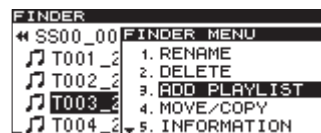

## 6 – File and folder operations (FINDER screen)

- 2 Press the MULTI JOG dial (or remote control ENTER button) to open the ADD PLAYLIST screen.

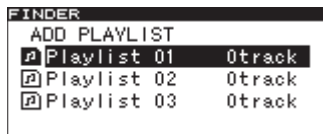

- 3 Turn the MULTI JOG dial (or push remote control ▲/▼ buttons) to select the destination playlist.
- 4 Press the MULTI JOG dial or ►► [LOCK] button (or remote control ENTER or ► button) to open the selected playlist.

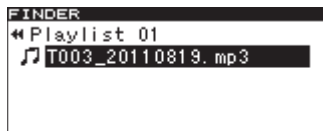

- 5 Turn the MULTI JOG dial (or push remote control ▲/▼ buttons) to set the location of the file that you are adding in the playlist. The inserted file will appear highlighted, and it will be inserted at that position.
- 6 Press the MULTI JOG dial (or remote control ENTER button) to add the file to the playlist. -- PLAYLIST -- and ADD appear in a pop-up and the file (or all files in the folder) are added to the playlist.



### NOTE

- A maximum of 99 tracks can be added to a playlist.
- If you attempt to add more than 99 tracks, a P.LIST FULL warning message pop-up will appear, and the track(s) will not be added.
- You cannot add the same track more than once to a playlist.

### Creating a new folder (USB/SD/CF media only)

- 1 Select the folder where you want to create a new folder, and turn the MULTI JOG dial (or push remote control ▲/▼ buttons) to select NEW FOLDER.

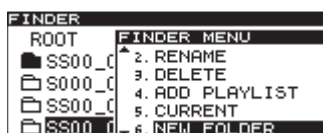

- 2 Press the MULTI JOG dial (or remote control ENTER button) to open the NEW FOLDER screen.

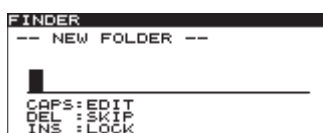

- 3 Input the folder name. Follow the instructions in "Inputting and editing characters" on page 48.
- 4 When you have completed inputting the folder name, press the MULTI JOG dial (or remote control ENTER button) to confirm the name.

-- FOLDER -- and a progress bar appear in a pop-up while the folder is being created.

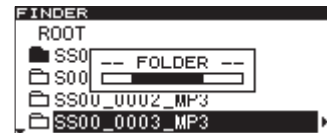

After the folder has been created, the FINDER screen reopens.

### NOTE

- A maximum of 255 folders can be created on a single USB memory or SD or CF card.
- When using media with a capacity of 2 GB or less, 255 folders cannot be created in the root folder due to file system limitations. A maximum of 255 folders, including subfolders, can be created.

### Moving and copying files (USB/SD/CF media only)

You can move a file within a folder on USB/SD/CF media, or move or copy it to a different folder. These operations are performed in the FINDER screen.

The following explanations assume that the FINDER screen for the applicable folder is displayed.

#### Moving a file within a folder

- 1 Select the file that you want to move, and turn the MULTI JOG dial (or push remote control ▲/▼ buttons) to select MOVE/COPY.



- 2 Press the MULTI JOG dial (or remote control ENTER button). The file to be moved blinks on the FINDER screen.



- 3 Turn the MULTI JOG dial (or push remote control ▲/▼ buttons) to move the selected file to the desired position.

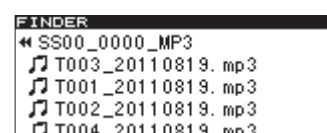

## 6 – File and folder operations (FINDER screen)

- Press the **MULTI JOG dial** (or remote control **ENTER button**) to confirm movement to the position.  
-- MOVE -- and a progress bar appear in a pop-up while the movement is completed.

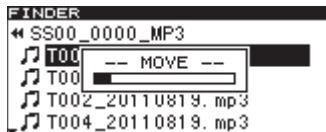

After the file name has been moved, the **FINDER** screen reopens.

- Select **MOVE** if you just want to move the file from its former location or **COPY** if you want to copy the file, and press the **MULTI JOG dial** (or remote control **ENTER button**).

-- MOVE -- or -- COPY -- (as appropriate) and a progress bar appear in a pop-up while the file is moved and copied.

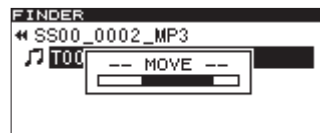

When set to **MOVE**

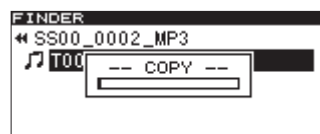

When set to **COPY**

### Move/copy files between folders

- Select the file to be moved and copied, and turn the **MULTI JOG dial** (or push remote control **▲/▼ buttons**) to select **MOVE/COPY**.

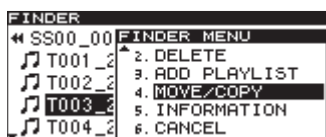

- Press the **MULTI JOG dial** (or remote control **ENTER button**). The file to be moved or copied blinks on the **FINDER** screen.

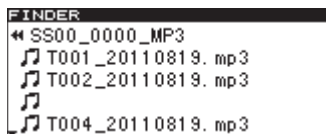

If you move the blinking file to where a folder name is shown, it will disappear (because it will be put in the folder) and the folder name will become selected.

- Use the **MULTI JOG dial** and **◀◀ [SKIP]** and **▶▶ [LOCK]** buttons (or remote control **▲/▼/◀** and **▶** buttons) to navigate the **FINDER** screen and open the destination folder.

If you move the cursor to where a file name is shown, the file moved will appear there blinking.

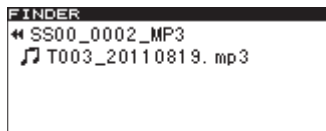

- Turn the **MULTI JOG dial** (or push remote control **▲/▼ buttons**) to move the blinking file to the position where you want it.  
Press the **MULTI JOG dial** (or remote control **ENTER button**) to show the following menu items in a pop-up.

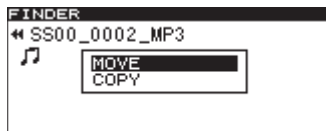

### NOTE

If you choose **COPY**, the original file will remain where it was. If you choose **MOVE**, the original file will not remain.

# 7 – Audio CD FINDER screen (SS-CDR200 only)

When working with CDs that have audio CD format files, you can use the audio CD FINDER screen to select tracks for playback. In addition, when working with unfinalized CD-R/CD-RW discs that have audio CD format files, you can also edit the CD-Text.

The following explanations assume that an audio CD is inserted and CD is selected as the current device.

## Opening the audio CD FINDER screen

When stopped, in playback standby or playing back, press the **FINDER [A-B]** button (or remote control **FINDER** button) to open the audio CD FINDER screen.

This screen shows the tracks in numerical order.

If you open this screen while stopped, track 1 will be selected.

When in playback standby or during playback, the current track will be selected.

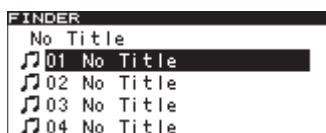

**To close the FINDER screen and return to the Home Screen:**

Press the **HOME/DISP** button (or remote control **HOME/DISP** button).

## Selecting a track to play

Follow these procedures on the audio CD FINDER screen to play back a track.

**1 Open the FINDER screen, and select the track to playback.**

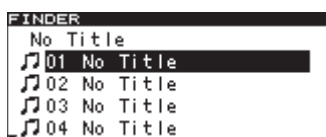

**2 Press the PLAY button (or remote control PLAY button)**

**When stopped, doing this will start playback of the selected track.**

**When in playback standby, doing this will start playback standby at the beginning of the selected track.**

## Editing CD-Text (CD-R/CD-RW disc only)

If you insert an unfinalized CD-R/CD-RW disc that has audio CD format files, you can follow these procedures to edit the CD-Text.

**1 Open the FINDER screen, and select the desired track.**

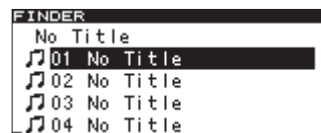

**2 Press the MULTI JOG dial (or remote control ENTER button) to open the CD-Text editing screen for the selected track.**



**3 Edit the text. Follow the instructions in "Inputting and editing characters" on page 48.**

**4 After you finish editing the CD-Text, press the MULTI JOG dial (or remote control ENTER button) to confirm the changes.**

After the CD-Text has been changed, the FINDER screen reopens.

### CAUTION

- If you press the **EJECT** button, the following warning message pop-up will appear.

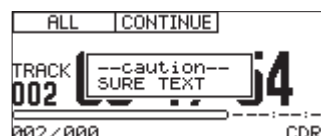

Finalize the disc in order to save the CD-TEXT. (See "Finalizing CD-R/CD-RW discs (SS-CDR200 only)" on page 53.)

### NOTE

- Names that contain characters other than the letters of the alphabet, numbers and symbols cannot be edited (the name will not appear when the **RENAME** function is being used).
- The following symbols and punctuation marks cannot be used in names.

\/;\*,?"<>|



# 8 – Using the EDIT menu (USB/SD/CF media only)

## Using the edit menu

Press the **EDIT [INPUT]** button (or remote control **EDIT** button) to open the EDIT menu pop-up.

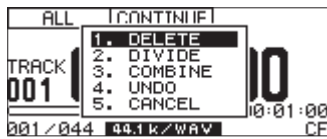

Turn the **MULTI JOG** dial (or press the remote control **▲** and **▼** buttons) to select the desired item. Then, press the **MULTI JOG** dial (or remote control **ENTER** button) to use the selected item.

### NOTE

If a write-protected SD card is loaded, the following operations are not possible. (See “SD card write protection” on page 26.)

### DELETE

Delete the selected file. (See “Deleting files” on page 57.)

### DIVIDE

Divide the selected file. (See “Dividing files” on page 57.)

### COMBINE

Combine the selected files. (See “Combining files” on page 58.)

### UNDO

Undo the last edit menu operation. (See “Undoing EDIT menu operations” on page 59.)

### CANCEL

Cancel the use of the EDIT menu, closing it and returning to the Home Screen. The **READY [CALL]** button will light.

## Deleting files

You can delete files shown on the Home Screen from the USB/SD/CF media.

This function can only be used when the playback mode is set to **CONTINUE**.

- 1 Use the **PLAY**, **◀◀ [SKIP]** and **▶▶ [LOCK]** buttons (or remote control **PLAY** and **SEARCH ◀◀/▶▶** buttons), as well as time searching, skipping backward and forward and other functions to locate the file you want to delete.
- 2 Press the **EDIT [INPUT]** button (or remote control **EDIT** button) to open the EDIT menu pop-up.
- 3 Turn the **MULTI JOG** dial (or press the remote control **▲** and **▼** buttons) to select **DELETE**.

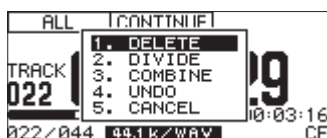

- 4 Press the **MULTI JOG** dial (or remote control **ENTER** button).

A confirmation pop-up message appears.



To delete, press the **EDIT [INPUT]** button (or remote control **EDIT** button).

- 5 Press the **MULTI JOG** dial (or remote control **ENTER** button) to delete the item from the USB/SD/CF media.

-- **ERASE** -- and a progress bar appear in a pop-up while the item is being deleted.



After deletion completes, the **FINDER** screen reopens.

### NOTE

Immediately after deleting a file, you can undo the operation. (See “Undoing EDIT menu operations” on page 59.)

## Dividing files

You can divide a recorded WAV file at the position you want into two files.

This function can only be used when the playback mode is set to **CONTINUE**.

### NOTE

- MP3 files cannot be divided.
  - Immediately after dividing a file, you can undo the operation. (See “Undoing EDIT menu operations” on page 59.)
- 1 Use the **PLAY**, **◀◀ [SKIP]** and **▶▶ [LOCK]** buttons (or remote control **PLAY** and **SEARCH ◀◀/▶▶** buttons), as well as time searching, skipping backward and forward and other functions to locate the general position where you want to divide the WAV file.  
You will be able to make fine adjustments later, so an approximate location is fine.
  - 2 During playback or when in playback standby, press the **EDIT [INPUT]** button (or remote control **EDIT** button) to open the EDIT menu pop-up.
  - 3 Turn the **MULTI JOG** dial (or press the remote control **▲** and **▼** buttons) to select **DIVIDE**.



## 8 – Using the EDIT menu (USB/SD/CF media only)

- 4 Press the **MULTI JOG** dial (or remote control **ENTER** button) to open the Home Screen in scrub playback mode.

In scrub playback mode, the track elapsed time in the **TRACK** mode area on the Home Screen will show the frame value. The **PLAY** and **READY [CALL]** buttons blink.

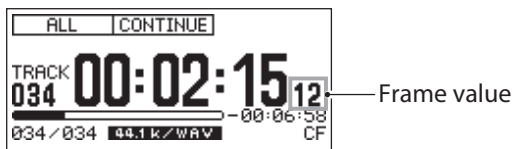

- 5 Use the scrub playback function to find the precise point where you want to divide the file. Turn the **MULTI JOG** dial (or remote control **SKIP** <</> buttons) to use scrub playback for adjusting the division point.
- 6 When you have set the division point, press the **MULTI JOG** dial (or remote control **ENTER** button). A confirmation pop-up message appears.

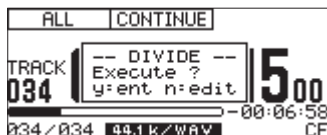

If you need to change the division point, press the **EDIT [INPUT]** button (or remote control **EDIT** button) to return to scrub playback mode and repeat step 5. To divide the file, proceed to step 7.

### NOTE

If a file has been added to a playlist, a **P.LIST ENTRY** warning message will appear in a pop-up. If a file that has been edited has been added to a playlist, that playlist will not be able to be played back. You will need to remove the divided files from the playlist on the **PLAYLIST EDIT** or **USER PLAYLIST** screen.

- 7 Press the **MULTI JOG** dial (or remote control **ENTER** button) to divide the file.  
-- DIVIDE -- and a progress bar appear in a pop-up while the file is being divided.

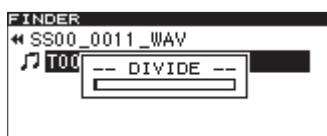

After division completes, the **FINDER** screen reopens.

## Combining files

You can combine two recorded WAV files into one file. This function can only be used when the playback mode is set to **CONTINUE**.

### NOTE

- You cannot combine MP3 files.

- You cannot combine two WAV files that have different sampling rates or different numbers of channels.
- You can undo the **COMBINE** operation after executing it. (See "Undoing EDIT menu operations" on page 59.)

- 1 Use the **PLAY**, << [SKIP] and >> [LOCK] buttons (or remote control **PLAY** and **SEARCH** <</> buttons), as well as time searching, skipping backward and forward and other functions to locate one of the files that you want to combine.
- 2 Press the **EDIT [INPUT]** button (or remote control **EDIT** button) to open the **EDIT** menu pop-up.
- 3 Turn the **MULTI JOG** dial (or press the remote control **▲** and **▼** buttons) to select **COMBINE**.



- 4 Press the **MULTI JOG** dial (or remote control **ENTER** button) to put a check mark (✓) next to the selected file.

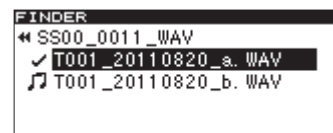

- 5 Turn the **MULTI JOG** dial (or press the remote control **▲** and **▼** buttons) to select the file that you want to combine with the checked file.
- 6 Press the **MULTI JOG** dial (or remote control **ENTER** button).

A confirmation pop-up message appears, the **PLAY** and **READY [CALL]** buttons blink, and the four seconds preceding and following the combination point will be played back repeatedly.

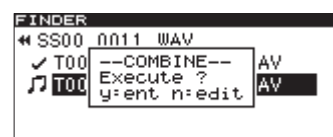

To cancel combination, press the **EDIT [INPUT]** button (or remote control **EDIT** button).

The **FINDER** screen will reopen. Repeat from step 4 if you still want to combine files.

### NOTE

If a file has been added to a playlist, a **P.LIST ENTRY** warning message will appear in a pop-up. If a file that has been edited has been added to a playlist, that playlist will not be able to be played back. You will need to remove the divided files from the playlist on the **PLAYLIST EDIT** or **USER PLAYLIST** screen.

- 7 To confirm and execute the combination, press the **MULTI JOG** dial (or remote control **ENTER** button).  
-- COMBINE -- and a progress bar appear in a pop-up while the files are being combined.

## 8 – Using the EDIT menu (USB/SD/CF media only)

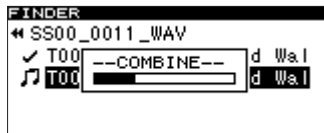

After combining completes, the FINDER screen reopens.

### Undoing EDIT menu operations

Among EDIT menu operations, the division, combination and deletion of files, as well as the deletion of folders can be undone immediately after the operation is executed.

This function can only be used when the playback mode is set to CONTINUE.

#### NOTE

When undoing, it does not matter which folder/file is selected on the FINDER screen before opening the EDIT menu.

- 1 Press the **EDIT [INPUT] button (or remote control EDIT button)** to open the EDIT menu pop-up.
- 2 Turn the **MULTI JOG dial (or press the remote control ▲ and ▼ buttons)** to select **UNDO**.

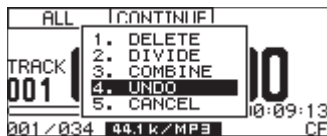

- 3 Press the **MULTI JOG dial (or remote control ENTER button)**.

A confirmation pop-up message appears.

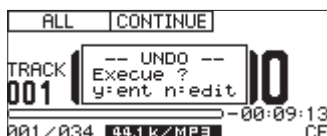

- 4 Press the **MULTI JOG dial (or remote control ENTER button)** to undo the last edit.

-- UNDO -- and a progress bar appear in a pop-up while the edit is being undone.



After undoing completes, the FINDER screen reopens. The folder/file that was affected by the undo operation will be selected.

#### NOTE

- To cancel the undo operation, press the **EDIT [INPUT] button (or remote control EDIT button)**.
- If there is no file operation that can be undone, a **CAN'T UNDO** warning message will appear in a pop-up.

# 9 – Editing the playlist (USB/SD/CF media only)

## Overview

When you first load USB/SD/CF media into the unit, the unit automatically creates three empty playlists (01–03) on the selected media. If you add audio files on the media to these playlists, and set the play area to a playlist, the files in the current playlist can be set as the current playback area.

To work with the playlist, from the **PLAY** menu, select the **P.L. EDIT** item to open the **PLAYLIST EDIT** screen. If the play area (see “Play area” on page 60) is set to **PLAYLIST**, the **USER PLAYLIST** screen opens instead.



PLAYLIST EDIT screen

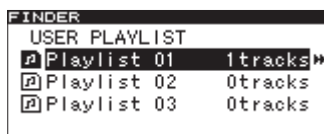

USER PLAYLIST screen

From these screens, proceed to the **Playlist XX** screen (“XX” is the list number), which shows the files in the playlist. After selecting the file that you want to work with, proceed to the playlist **FINDER MENU** to add the file to the playlist. You can also move or remove files in the playlist.

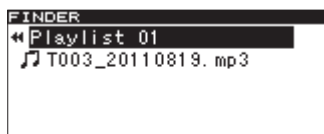

Playlist 01 screen

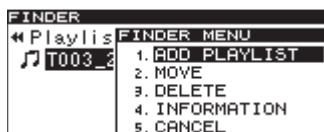

Playlist FINDER MENU

## Open the USER PLAYLIST screen

If the play area is set to **PLAYLIST** (see “Play area” on page 60), and the unit is stopped, playing or in playback standby, press the **FINDER [A-B]** button (or remote control **FINDER** button) to open the **USER PLAYLIST** screen.

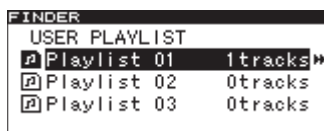

## Navigating the playlist screen

On the **PLAYLIST EDIT** and **USER PLAYLIST** screens, three playlists (**PLAYLIST 01**–**PLAYLIST 03**) are shown.

The numbers of files (tracks) in each playlist are shown to their right.

When the **PLAYLIST EDIT** or **USER PLAYLIST** screen is open, turn the **MULTI JOG** dial (or press the remote control **▲** and **▼** buttons) to select the playlist that you want to work with. In this state, you can perform the following operations.

- **To start playback from the beginning of the playlist:**

When the **USER PLAYLIST** screen is open, press the front panel or remote control **PLAY** button.

When playback starts, the Home Screen reopens. The selected playlist becomes set as the current playlist.

- **To start playback standby at the beginning of the playlist:**

When the **USER PLAYLIST** screen is open, press the **READY [CALL]** button (or remote control **READY** button).

When playback standby starts, the Home Screen reopens. The selected playlist becomes set as the current playlist.

- **To open the playlist screen:**

When the **PLAYLIST EDIT** or **USER PLAYLIST** screen is open, press the **MULTI JOG** dial or **/▶▶ [LOCK]** button (or remote control **ENTER** or **▶** button).

The **Playlist XX** screen (“XX” is the list number) shows the files in the playlist



- **To open the playlist FINDER MENU:**

When the **Playlist XX** screen (“XX” is the list number) is open, press the **MULTI JOG** dial (or remote control **ENTER** button) to open the playlist **FINDER MENU** pop-up. For details about the items in the **FINDER MENU** pop-up, see “Using the playlist **FINDER MENU**” on the next page.

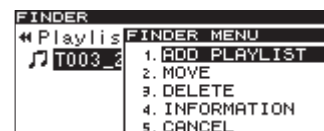

# 9 – Editing the playlist (USB/SD/CF media only)

## Using the playlist FINDER MENU

You can use the playlist **FINDER MENU** to add files to a playlist, as well as to move and remove them.

The following explanations assume that the **Playlist XX** screen ("XX" is the list number) for the desired playlist is open.

To open the playlist **FINDER MENU** pop-up, select the desired playlist from the **PLAYLIST EDIT** or **USER PLAYLIST** screen, and press the **MULTI JOG** dial (or remote control **ENTER** button). (See "Navigating the playlist screen" on page 61.)

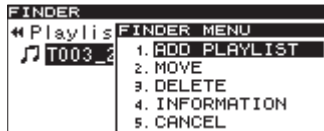

Turn the **MULTI JOG** dial (or push remote control **▲/▼** buttons) to select the desired item, and press the **MULTI JOG** dial (or remote control **ENTER** button) to execute the selected operation.

### NOTE

If a write-protected SD card is loaded, the **ADD PLAYLIST**, **MOVE** and **DELETE** items cannot be used. (See "SD card write protection" on page 26.)

### ADD PLAYLIST

Add a file to the selected playlist. (See "Adding files to playlists" on page 61.)

### MOVE

Move the selected file within the same playlist. (See "Moving and copying files (USB/SD/CF media)" on page 54.)

### DELETE

Open a pop-up message confirmation that you want to remove the file from the playlist.

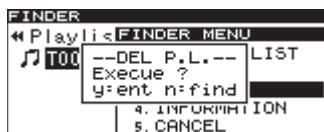

Press the **MULTI JOG** dial (or remote control **ENTER** button) to remove the file from the playlist, or press the **FINDER [A-B]** button (or remote control **FINDER** button) to cancel removal.

### INFORMATION

Shows the number of tracks in the playlist and its total playback time in a pop-up.

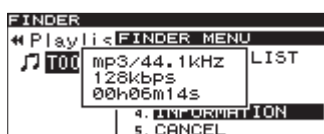

### CANCEL

Cancels any operation related to the selected file, closing the playlist **FINDER MENU** and returning to the **Playlist XX** screen ("XX" is the list number).

## Adding files to playlists

Follow these procedures to add individual files to playlists. You can also add all the files in a folder at once.

- 1 Turn the **MULTI JOG** dial (or press the remote control **▲** and **▼** buttons) to select **ADD PLAYLIST**.
- 2 Press the **MULTI JOG** dial (or remote control **ENTER** button) to open the **FINDER** screen.

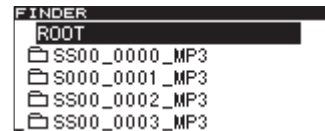

- 3 Select the file or folder that you want to add. For instructions about using the **FINDER** screen, see "Navigating the **FINDER** screen" on page 50. If you select a folder, all the files in the folder will be added.

### NOTE

Files in subfolders will not be added.

- 4 Press the **MULTI JOG** dial (or remote control **ENTER** button).  
-- **PLAYLIST** -- and **ADD** appear in a pop-up and the file (or all files in the folder) are added to the playlist.



### NOTE

- A maximum of 99 tracks can be in a playlist.
- If you attempt to add more than 99 tracks, a **PLIST FULL** warning message pop-up will appear, and the track(s) will not be added.
- You cannot add the same track more than once to a playlist.

## 9 – Editing the playlist (USB/SD/CF media only)

### Removing files from playlists

Follow these procedures to remove one or all files from a playlist.

Even though files are “deleted” from the playlist, they are not deleted from the media.

- 1 Turn the **MULTI JOG dial** (or press the remote control **▲** and **▼** buttons) to select a playlist or a file in a playlist. (If a playlist is selected, all the files will be removed from the playlist.)
- 2 Press the **MULTI JOG dial** (or remote control **ENTER** button) to open the **FINDER MENU** pop-up.
- 3 Turn the **MULTI JOG dial** (or press the remote control **▲** and **▼** buttons) to select **DELETE**.
- 4 Press the **MULTI JOG dial** (or remote control **ENTER** button).  
A confirmation pop-up message appears.
- 5 Press the **MULTI JOG dial** (or remote control **ENTER** button) to remove the file(s).  
To cancel removal, press the **FINDER [A-B]** button (or remote control **FINDER** button).

### Moving a file in a playlist

You can change the position of a file in a playlist.

- 1 Select the file to move.
- 2 Press the **MULTI JOG dial** (or remote control **ENTER** button) to open the **FINDER MENU** pop-up.
- 3 Turn the **MULTI JOG dial** (or press the remote control **▲** and **▼** buttons) to select **MOVE**.  
The file to be moved blinks on the **FINDER** screen.



- 4 Turn the **MULTI JOG dial** (or press the remote control **▲** and **▼** buttons) to move that file to the desired position.

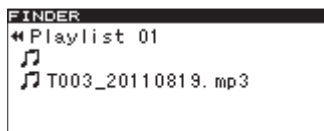

- 5 Press the **MULTI JOG dial** (or remote control **ENTER** button) to confirm the new position after moving.  
-- **PLAYLIST** -- and a progress bar appear in a pop-up while the movement completes, and then the **Playlist XX** screen reopens.

# 10 - Copying files between CDs and other media (SS-CDR200)

You can copy (or convert and copy) files on USB/SD/CF media to a blank CD. You can also copy (or convert and copy) files on a CD to USB/SD/CF media.

Copying is only possible from the **CD** menu, so set the current device to **CD**. Before conducting the following operations, load appropriate CD and USB/SD/CF media in the unit.

## NOTE

You cannot copy to a write-protected SD card. (See "SD card write-protection" on page 26.)

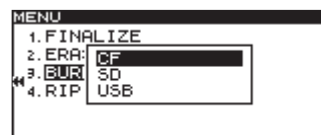

- 5 Turn the **MULTI JOG dial** (or press the remote control **▲** and **▼** buttons) to select the device that contains the files to be copied.
- 6 Press the **MULTI JOG dial** (or remote control **ENTER** button) to open a pop-up window where you can select the **CD-R/CD-RW** disc format.

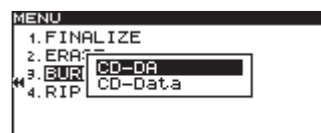

## Copy/convert and copy files from USB/SD/CF media to blank CDs

When copying MP3 or WAV files from USB/SD/CF media to a blank CD, you can copy the files in the same file format to make a data CD or convert the files into audio CD format when copying.

If you select audio CD format, MP3 and WAV files on USB/SD/CF media will be converted to audio CD format and copied to a blank CD.

If you use an unfinalized CD-R/CD-RW disc that already has tracks on it, the disc format is already set as audio CD or data CD, and that format must be used.

## NOTE

- This unit cannot record WAV files to CD-R/CD-RW discs, but WAV files can be copied from USB/SD/CF media to CD-R/CD-RW discs.
- This unit can play back WAV files copied to CD-R/CD-RW discs.

## NOTE

- If the selected device media is still being read, **MEDIA READ** and a progress bar appear in a pop-up.
  - If media is not loaded in the selected device, **MEDIA READ** appears in a pop-up followed by **ERROR** and the media type (e.g. **CF READ**).
- 7 Turn the **MULTI JOG dial** (or press the remote control **▲** and **▼** buttons) to select **CD-DA**.

## NOTE

If audio format files have already been written to the CD-R/CD-RW disc, the above pop-up window will not appear. **CD-DA** format will be selected automatically.

- 8 Press the **MULTI JOG dial** (or remote control **ENTER** button) to open the **BURN SOURCE SELECT** screen for the selected media.

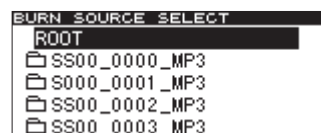

## Creating audio CDs

The following describes how to convert MP3 or WAV files on USB/SD/CF media to audio CD format and write them to a CD-R/CD-RW disc.

The following procedure assumes that **CD** is selected as the current device and that the USB/SD/CF media that contains the copy-source files and the CD-R/CD-RW that is the copy destination are loaded in the unit.

- 1 Press the **MENU [JOG] button** (or remote control **MENU** button) to open the **MENU** screen.
- 2 Open the **CD** menu.
- 3 Select **BURN TO CD**.

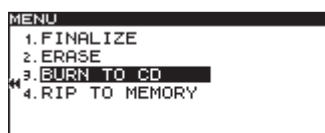

- 4 Press the **MULTI JOG dial** (or remote control **ENTER** button) to open a pop-up window where you can select the source device.

- 9 Select the tracks to copy to the CD-R/CD-RW disc from the **BURN SOURCE SELECT** screen.

You cannot select a folder.

To select multiple files, when the desired file is selected, press the **FUNCTION** button (or remote control **FUNC** button). Repeat this for each file.

Checkmarks (✓) are placed next to selected files. You can only select multiple files that are in the same folder.

To deselect a selected file, press the **FUNCTION** button (or remote control **FUNC** button) once again.

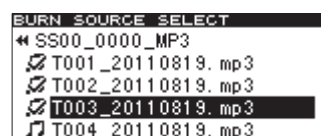

## NOTE

- You can select multiple files only within the same folder, so once you use the **FUNCTION** button (or

## 10 - Copying files between CDs and other media (SS-CDR200)

remote control **FUNC** button) to select the first file, you will no longer be able to move to a different folder.

- In step 10 below, if you attempt to use **ADD TRACK** with a file that has already been selected, an **Already has been entered** warning message appears in a pop-up.
- If you attempt to select a copy-source file that is less than 4 seconds, **Cannot burn under 4s** will appear in a pop-up.
- If you are selecting only one file, there is no need to press the **FUNCTION** button (or remote control **FUNC** button). After selecting the desired file, proceed to step 10.

**10 When you have selected all the files to be written to the CD-R/CD-RW disc, press the MULTI JOG dial (or remote control ENTER button) to confirm the selections and open the TRACK LIST screen.**

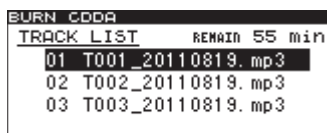

The time that will remain (REMAIN XXmin) on the CD-R/CD-RW disc after the files have been written will be displayed in the upper right of the screen.

If the allowable time is exceeded, **OVER** will appear instead, and you will not be able to write the selected files to the CD-R/CD-RW disc. In this case, you'll need to delete some of the selected source files until the **OVER** indication disappears.

If there are files that have already been written to the disc, these files will also be shown in this list.

Note marks (✓) will appear next to existing tracks. Note marks (✗) will not appear next to tracks that will be added.

### NOTE

As necessary, you can change the track order or remove files. For details about how to change and remove files, see "Moving files within the track list" and "Removing files from the track list" below.

**11 To write the files, press the MULTI JOG dial (or remote control ENTER button) to open the following pop-up window.**



**12 If you want to add more tracks, choose ADD TRACK and press the MULTI JOG dial (or remote control ENTER button) to return to step 9.**

If you have completed selecting tracks, select **BURN EXECUTE**, and press the **MULTI JOG** dial (or remote control **ENTER** button).

A confirmation pop-up message appears.

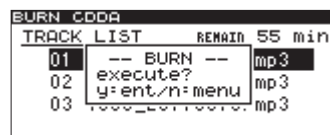

**13 Press the MULTI JOG dial (or remote control ENTER button) again to start writing tracks to the CD-R/CD-RW disc.**

-- BURN -- and a progress bar appear in a pop-up while the disc is being written.



When writing is completed, the CD menu screen will reopen.

### ■ Moving files within the track list

While the **TRACK LIST** screen is open, you can follow these procedures to change the track order. You cannot change the order of tracks that have already been written to a CD-R/CD-RW disc.

- 1 Turn the **MULTI JOG** dial (or press the remote control **▲** and **▼** buttons) to select the track that you want to move to a different position.
- 2 Press the **MULTI JOG** dial (or remote control **ENTER** button) to open a pop-up window.
- 3 Select **MOVE TRACK**, and press the **MULTI JOG** dial (or remote control **ENTER** button).  
The file selected for moving blinks.
- 4 Turn the **MULTI JOG** dial (or press the remote control **▲** and **▼** buttons) to move the selected file to the desired position.
- 5 Press the **MULTI JOG** dial (or remote control **ENTER** button) to confirm the move.
- 6 Repeat steps 1–5 as necessary.

### ■ Removing files from the track list

While the **TRACK LIST** screen is open, you can follow these procedures to remove a file. You cannot remove a file that has already been written to a CD-R/CD-RW disc.

- 1 Press the **MENU [JOG]** dial (or remote control **MENU** button) to open the **FINDER** screen for the selected media.
- 2 Turn the **MULTI JOG** dial (or press the remote control **▲** and **▼** buttons) to select the file you want to remove.
- 3 Press the **MULTI JOG** dial (or remote control **ENTER** button) to remove the checkmark (✓) next to the file you want to remove.
- 4 Repeat steps 2–3 as necessary.



# 10 - Copying files between CDs and other media (SS-CDR200)

## Creating data CDs

This section explains how files (MP3 or WAV files) from a USB/SD/CF media can be copied in their current format to create a data CD.

The following procedures assume that CD is set as the current device and that USB/SD/CF media that includes copy-source files and the destination CD-R/CD-RW disc are loaded.

### NOTE

You can copy WAV files on USB/SD/CF media to a CD-R/CD-RW disc but you cannot record WAV files using a CD using this unit.

- 1 Press the **MENU [JOG]** button (or remote control **MENU** button) to open the **MENU** screen.
- 2 Open the **CD** menu.
- 3 Select **BURN TO CD**, and press the **MULTI JOG** dial (or remote control **ENTER** button).



- 4 Press the **MULTI JOG** dial (or remote control **ENTER** button) to open a pop-up window where you can select the device used.

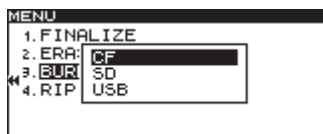

- 5 Turn the **MULTI JOG** dial (or press the remote control **▲** and **▼** buttons) to select the device that contains the files to be copied.
- 6 Press the **MULTI JOG** dial (or remote control **ENTER** button) to open a pop-up window where you can select the format for writing the CD-R/CD-RW disc.



### NOTE

- If the selected device media is still being read, **MEDIA READ** and a progress bar appear in a pop-up.
  - If the selected device media is not loaded, after **MEDIA READ**, **ERROR** and the media type (**CF READ**, etc.) appears in a pop-up.
- 7 Turn the **MULTI JOG** dial (or press the remote control **▲** and **▼** buttons) to select **CD-Data**.

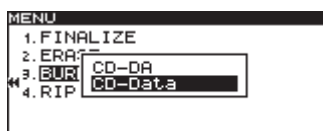

### NOTE

If audio format files have already been written to the CD-R/CD-RW disc, the above pop-up window will not appear. **CD-Data** format will be selected automatically.

- 8 Press the **MULTI JOG** dial (or remote control **ENTER** button) to open the **FINDER** screen for the selected media.

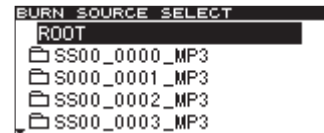

- 9 Select the folder or file from the **FINDER** screen to copy to the CD-R/CD-RW disc. If you select a folder, all the files in the folder will be copied.

To select multiple files or folders, when the desired file or folder is selected, press the **FUNCTION** button (or remote control **FUNC** button). Repeat this for every file and folder.

Checkmarks (✓) are placed next to selected files and folders. You can only select multiple files and folders if they are in the same folder.

To deselect a selected file or folder, press the **FUNCTION** button (or remote control **FUNC** button) once again.

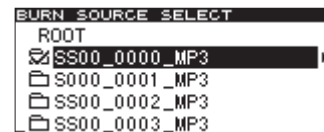

### NOTE

- You can select multiple files and folders only within the same folder, so once you use the **FUNCTION** button (or remote control **FUNC** button) to select the first file or folder, you will no longer be able to move to a different folder.
- If you are selecting only one file or folder, there is no need to press the **FUNCTION** button (or remote control **FUNC** button). After selecting the desired file, proceed to step 10.

- 10 When you have selected all of the files to be written to the CD-R/CD-RW disc, press the **MULTI JOG** dial (or remote control **ENTER** button) to confirm the selections and open the **BURN TARGET SELECT** screen.



### NOTE

- If the selected copy-source files would exceed the free space on the disc or the allowable number of tracks, you will not be able to proceed to the **BURN TARGET SELECT** screen. In this case, delete some of the selected folders or files so that the limit is no longer exceeded.

## 10 - Copying files between CDs and other media (SS-CDR200)

- If the total size of the copy-source files exceeds the free space on the copy-destination disc, **CAPACITY OVER** appears in a pop-up after step 10.
- If copying the copy-source files would exceed the allowable number of tracks on the disc, **TRACK OVER** appears in a pop-up after step 10.

### 11 Turn the MULTI JOG dial (or press the remote control ▲ and ▼ buttons) to select the destination for the files.

If the disc already has a folder structure, select a file or folder on the **FINDER** screen.

The folders or files will be copied after the selected folder or file.



### 12 Press the MULTI JOG dial (or remote control ENTER button) to confirm the selection.

A confirmation pop-up message appears.

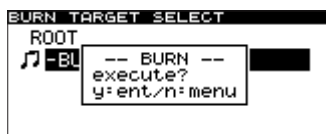

#### NOTE

If there are files with the same name, the following pop-up message will appear.

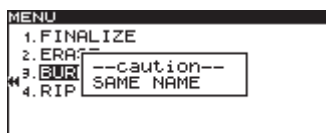

After this, the pop-up message disappears and the **CD** menu screen opens.

### 13 Press the MULTI JOG dial (or remote control ENTER button) again to start writing to the CD-R/CD-RW disc.

-- BURN -- and a progress bar appear in a pop-up while the disc is being written.



When writing is completed, the **CD** menu screen will reopen.

#### NOTE

When you press the **EJECT** button, the CD-R/CD-RW disc will be finalized automatically before it is ejected. (See "Finalizing CD-R/CD-RW discs (SS-CDR200 only)" on page 43.)

## Converting CD files and copying them to USB/SD/CF media

You can copy files from a CD to USB/SD/CF media with or without conversion. When copying from an audio CD to the media, each track file will be converted into the format you specify (MP3 or WAV file).

When copying from a CD-R/CD-RW disc that contains MP3 or WAV files, the files can be copied in their current format.

## Converting and copying audio CD tracks

The following explains how to convert audio CD format files on a CD into MP3 and WAV format and copy them to the selected media (USB/SD/CF media).

The following procedure assumes that **CD** is selected as the current device and that a CD that contains the copy-source files and the copy destination media are loaded in the unit.

- 1 Press the **MENU [JOG]** button (or remote control **MENU** button) to open the **MENU** screen.
- 2 Open the **CD** menu.
- 3 Select **RIP TO MEMORY**, and press the **MULTI JOG** dial (or remote control **ENTER** button).

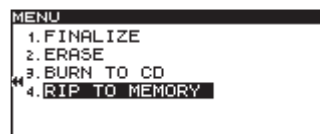

- 4 Press the **MULTI JOG** dial (or remote control **ENTER** button) to open a pop-up window where you can select the device used.

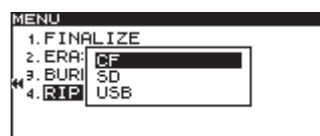

- 5 Turn the **MULTI JOG** dial (or press the remote control ▲ and ▼ buttons) to select the copy destination device.
- 6 Press the **MULTI JOG** dial (or remote control **ENTER** button) to open a pop-up window where you can set the file format.

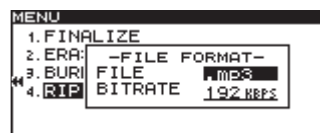

#### NOTE

- If the selected device media is still being read, **MEDIA READ** and a progress bar appear in a pop-up.
- If the selected device media is not loaded, after **MEDIA READ, ERROR** and the media type (**CF READ**, etc.) appears in a pop-up.

# 10 - Copying files between CDs and other media (SS-CDR200)

- Turn the **MULTI JOG** dial (or press the remote control **▲** and **▼** buttons) to select the file format to be saved to the selected device media.

## FILE

Set the file format.

Options: .MP3 (default value), .WAV

## BITRATE

Set the MP3 format bit rate.

Options: 64kbps, 128kbps, 192kbps (default value), 256kbps, 320kbps

## NOTE

The sampling frequency is fixed at 44.1 kHz for files stored on the selected device media.

- After you have completed all settings, press the **MULTI JOG** dial (or remote control **ENTER** button) to open the **RIP SOURCE SELECT** screen.

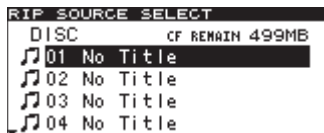

- Select the tracks to copy.

Select a source track, and press the **FUNCTION** button (or remote control **FUNC** button) to put a checkmark (✓) next to it. Repeat this to select multiple files.

To deselect a selected file, press the **FUNCTION** button (or remote control **FUNC** button) once again.

The time that will remain on the media after the files have been written will be displayed in the upper right of the screen.

## NOTE

- When you are selecting source files, if their size would exceed the remaining capacity of the selected media, or the number of source tracks would cause the number of files on the selected media to exceed the limit, **OVER** will appear and you will not be able to continue to step 10. Deselect some of the files, for example, until **OVER** is no longer shown.



- If you are selecting only one file or folder, there is no need to press the **FUNCTION** button (or remote control **FUNC** button). After selecting the desired file, proceed to step 10.

- When you have selected all of the files you want to copy, press the **MULTI JOG** dial (or remote control **ENTER** button) to confirm the selections and open the **RIP TARGET SELECT** screen where you can select the copy destination.

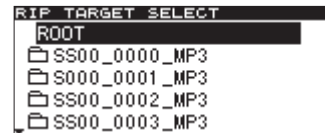

- Select the copy destination from the **RIP TARGET SELECT** screen.

The folders or files will be copied after the selected folder or file.



- Press the **MULTI JOG** dial (or remote control **ENTER** button) to confirm the copy destination.

A confirmation pop-up message appears.

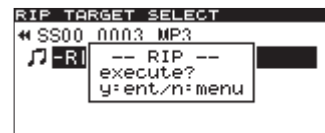

- Press the **MULTI JOG** dial (or remote control **ENTER** button) again to start writing to the selected device media.

-- RIP -- and a progress bar appear in a pop-up while the files are copied.



When writing is completed, the CD menu screen will reopen.

## Copying files on a data CD

The following explains how to copy MP3 and WAV files on a data CD without changing their formats to the selected media (USB/SD/CF media).

The following procedure assumes that **CD** is selected as the current device and that a CD-R/CD-RW that contains the copy-source files and the copy destination media are loaded in the unit.

- Press the **MENU [JOG]** button (or remote control **MENU** button) to open the **MENU** screen.
- Open the **CD** menu.
- Select **RIP TO MEMORY**, and press the **MULTI JOG** dial (or remote control **ENTER** button).

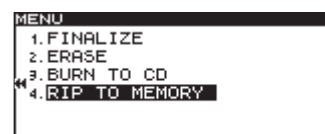

# 10 - Copying files between CDs and other media (SS-CDR200)

- Press the **MULTI JOG** dial (or remote control **ENTER** button) to open a pop-up window where you can select the device.

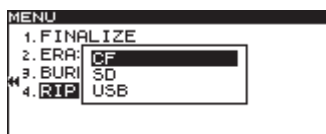

- Turn the **MULTI JOG** dial (or press the remote control **▲** and **▼** buttons) to select the copy destination device.

### NOTE

- If the selected device media is still being read, **MEDIA READ** and a progress bar appear in a pop-up.
- If the selected device media is not loaded, after **MEDIA READ**, **ERROR** and the media type (**CF READ**, etc.) appears in a pop-up.

- Press the **MULTI JOG** dial (or remote control **ENTER** button) to open the **RIP SOURCE SELECT** screen.



- Select the file or folder to copy from the **RIP SOURCE SELECT** screen. If you select a folder, all the files in the folder will be copied.

To select multiple files or folders, when the desired file or folder is selected, press the **FUNCTION** button (or remote control **FUNC** button). Repeat this for every file and folder.

Checkmarks (✓) are placed next to selected files and folders. You can only select multiple files and folders if they are in the same folder.

To deselect a selected file or folder, press the **FUNCTION** button (or remote control **FUNC** button) once again.



### NOTE

- You can select multiple files and folders only within the same folder, so once you use the **FUNCTION** button (or remote control **FUNC** button) to select the first file or folder, you will no longer be able to move to a different folder.
  - If you are selecting only one file or folder, there is no need to press the **FUNCTION** button (or remote control **FUNC** button). After selecting the desired file, proceed to step 5.
- When you have selected all of the files you want to copy, press the **MULTI JOG** dial (or remote control **ENTER** button) to confirm the selections and open

the **RIP TARGET SELECT** screen where you can select the copy destination.

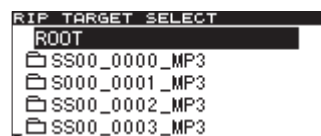

### NOTE

If the size of the source exceeds the remaining capacity of the selected media, or the number of source tracks would cause the number of files on the selected media to exceed the limit file, a **CAPACITY OVER** or a **TRACK OVER** message pop-up will appear accordingly, and you will not be able to confirm the source selection. If this occurs, press the **STOP** button to close the pop-up, and deselect some source files until the total size or number is acceptable. Then, press the **MULTI JOG** dial (or remote control **ENTER** button) again.

- Select the copy destination from the **RIP TARGET SELECT** screen.

The folders or files will be copied after the selected folder or file.



- Press the **MULTI JOG** dial (or remote control **ENTER** button) to confirm the copy destination.

A confirmation pop-up message appears.

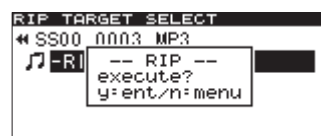

### NOTE

If there are files with the same name, the following pop-up message will appear.



After this, the pop-up message disappears and the **CD** menu screen opens.

- Press the **MULTI JOG** dial (or remote control **ENTER** button) again to start writing to the selected device media.

-- RIP -- and a progress bar appear in a pop-up while the files are copied.



When writing is completed, the **CD** menu screen will reopen.

# 11 – CD-RW management (SS-CDR200 only)

Using the CD menu to work with CD-RW discs, you can erase, unfinalize and refresh (completely erase) discs as well as erase tracks. This chapter explains these CD-RW management functions.

The following explanations assume that CD is selected as the current device and that a CD-RW is loaded.

## NOTE

You can also use the CD menu to finalize CD-R/CD-RW discs, and copy files between CDs and USB, SD and CF media. Finalizing is explained in “4 – Recording” (“Finalizing CD-R/CD-RW discs” on page 43), and copying files between CDs and USB, SD and CF media is explained in “10 – Copying files between CDs and USB, SD and CF media” (page 63).

## Unfinalizing CD-RW discs

If a finalized CD-RW disc is loaded, you can use the ERASE item to unfinalize the disc.

- 1 Press the MENU [JOG] button (or remote control MENU button) to open the MENU screen.
- 2 Open the CD menu.
- 3 Select ERASE.

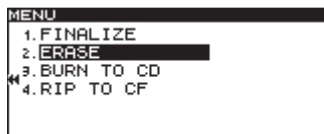

- 4 Press the MULTI JOG dial (or remote control ENTER button) to open a pop-up window where you can select the Erase Media item.



- 5 Turn the MULTI JOG dial (or press the remote control ▲ and ▼ buttons) to select Unfinalize.

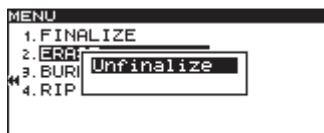

- 6 Press the MULTI JOG dial (or remote control ENTER button).

A confirmation pop-up message appears.

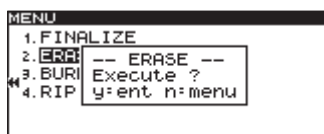

- 7 Press the MULTI JOG dial (or remote control ENTER button) again to start unfinalizing the disc.

-- UNFINALIZE -- and a progress bar appear in a pop-up while the disc is being unfinalized.

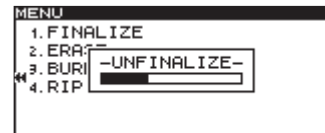

When unfinalizing is completed, the CD menu will reopen.

## Erasing CD-RW discs

You can completely erase an entire CD-RW disc.

- 1 Press the MENU [JOG] button (or remote control MENU button) to open the MENU screen.
- 2 Open the CD menu.
- 3 Select ERASE.
- 4 Press the MULTI JOG dial (or remote control ENTER button) to open a pop-up window where you can select the Erase Media item.
- 5 Turn the MULTI JOG dial (or press the remote control ▲ and ▼ buttons) to select Erase Media.



- 6 Press the MULTI JOG dial (or remote control to select button).

A confirmation pop-up message appears.

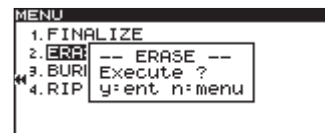

- 7 Press the MULTI JOG dial (or remote control ENTER button) again to start erasing the disc.

-- ERASE -- and a progress bar appear in a pop-up while the disc is being erased.



After erasing the disc completes, the CD menu will reopen.

## NOTE

If you erase a finalized CD-RW disc, the unit will unfinalize the disc before erasing it.

# 11 – CD-RW management (SS-CDR200 only)

## Erasing tracks

You can erase tracks that have been recorded in audio CD format on a CD-RW disc. The specified track and all later tracks (until the last track on the disc) will be erased.

- 1 Press the **MENU [JOG]** button (or remote control **MENU** button) to open the **MENU** screen.
- 2 Open the **CD** menu.
- 3 Select **ERASE**.
- 4 Press the **MULTI JOG** dial (or remote control **ENTER** button) to open a pop-up window where you can select the **Erase Track** item.
- 5 Turn the **MULTI JOG** dial (or press the remote control **▲** and **▼** buttons) to select **Erase Track**.

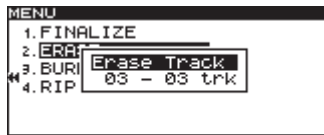

- 6 Press the **MULTI JOG** dial (or remote control **ENTER** button) to enable selection of the first track in the range of tracks that will be erased.

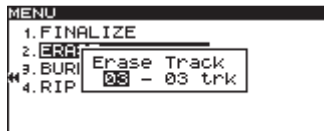

- 7 Turn the **MULTI JOG** dial (or press the remote control **▲** and **▼** buttons) to select the first track to erase in the range of tracks that will be erased. In the example above, track **03** is selected.

The last track to be deleted (shown as **03** in the illustration above) is fixed as the last track of the disc and cannot be changed.

- 8 After you have selected the first track, press the **MULTI JOG** dial (or remote control **ENTER** button).

A confirmation pop-up message appears.

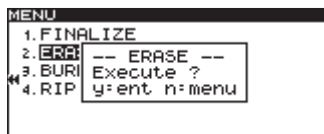

- 9 Press the **MULTI JOG** dial (or remote control **ENTER** button) again to start erasing tracks.

-- ERASE -- and a progress bar appear in a pop-up while tracks are being erased.



After the tracks have been erased, the **CD** menu will reopen.

## NOTE

- When erasing tracks on a finalized CD-RW disc, the unit will unfinalize the disc before erasing the designated tracks.
- This operation can be executed only on a disc that has audio CD format files

## Refreshing discs

You can refresh (completely erase) a CD-RW disc. The unit might not be able to recognize a CD-RW disc in some cases, such as if finalization was interrupted by a power failure, or if a disc has been used by a computer. In such cases, follow these procedures to refresh the CD-RW disc so that the unit can recognize it.

- 1 Press the **MENU [JOG]** button (or remote control **MENU** button) to open the **MENU** screen.
- 2 Open the **CD** menu.
- 3 Select **ERASE**.
- 4 Press the **MULTI JOG** dial (or remote control **ENTER** button) to open a pop-up window where you can select the **Refresh** item.
- 5 Turn the **MULTI JOG** dial (or press the remote control **▲** and **▼** buttons) to select **Refresh**.

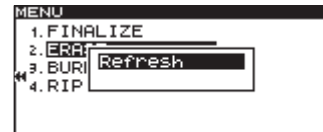

- 6 Press the **MULTI JOG** dial (or remote control **ENTER** button).

A confirmation pop-up message appears.

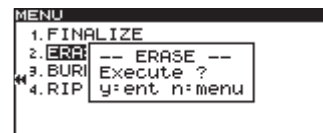

- 7 Press the **MULTI JOG** dial (or remote control **ENTER** button) again to start refreshing the CD-RW disc.

-- REFRESH --" and a progress bar appear in a pop-up while the disc is being refreshed.



After the CD-RW disc has been refreshed, the **CD** menu will reopen.

# 12 – Other settings and media information

## Footswitch control

You can operate this unit using a TASCAM RC-3F footswitch (sold separately) connected to the front panel **REMOTE** jack.

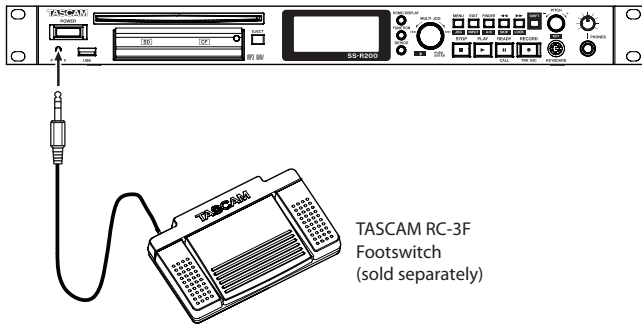

## Setting up a footswitch

- 1 Press the **MENU [JOG]** button (or remote control **MENU** button) to open the **MENU** screen.
- 2 Open the **UTILITY** menu.
- 3 Select **RC-3F MODE**.

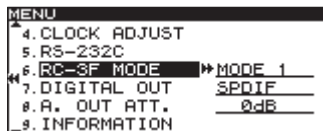

- 4 Press the **MULTI JOG** dial or **▶▶ [LOCK]** button (or remote control **ENTER** or **▶** button) to move the cursor to the right and select the setting item.
- 5 Turn the **MULTI JOG** dial (or press the remote control **▲** and **▼** buttons) to select one of the three pedal assignment modes.  
Options: **MODE 1** (default value), **MODE 2**, **MODE 3**
- 6 When you have finished making the setting, press the **HOME/DISPLAY** button (or remote control **HOME/DISP** button) to return to the Home Screen.

### NOTE

The footswitch (RC-3F MODE) setting is retained even after the power is turned OFF.

## Using the footswitch

When pushed, each of the footswitch pedals will operate according to the setting made with the **RC-3F MODE** item.

## Footswitch mode functions

The functions of the footswitches in each mode are as follows.

MODE	Footswitch		
	L (press)	C (press)	R (press)
1	⏪	PLAY	⏩
	⏮	READY/STOP	⏭
2	⏪	PLAY/PAUSE	⏩
	⏮	—	⏭
3	PITCH (-)	PLAY/PAUSE	PITCH (+)
	—	—	—

MODE 1: Optimal for transcribing meetings and working with similar recordings

MODE 2: Basic transport control

MODE 3: Pitch control

## Setting the digital output format

The digital output format of this unit can be set to either **SPDIF** or **AES/EBU**.

Use the menu as follows to set it.

- 1 Press the **MENU [JOG]** button (or remote control **MENU** button) to open the **MENU** screen.
- 2 Open the **UTILITY** menu.
- 3 Select **DIGITAL OUT**.

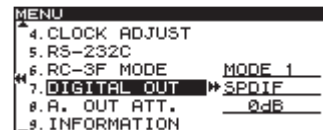

- 4 Press the **MULTI JOG** dial or **▶▶ [LOCK]** button (or remote control **ENTER** or **▶** button) to move the cursor to the right and select the setting item.
- 5 Turn the **MULTI JOG** dial (or press the remote control **▲** and **▼** buttons) to set the digital output format.  
Options: **SPDIF** (default value), **AES/EBU**
- 6 When you have finished making the setting, press the **HOME/DISPLAY** button (or remote control **HOME/DISP** button) to return to the Home Screen.

### NOTE

The **DIGITAL OUT** setting is retained even after the power is turned OFF.

## 12 – Other settings and media information

### Setting the analog output attenuation function

If sound distorts from an output destination device at maximum output level, you can use this unit's analog output attenuation function, which lowers the output level, to stop distortion.

1. Press the **MENU [JOG]** button to open the **MENU** screen.
2. Open the **UTILITY** menu screen.
3. Select the **A. OUT ATT.** item.



4. Press the **MULTI JOG** dial or **▶▶ [LOCK]** button (or remote control **ENTER** or **▶** button) to move the cursor right and select the setting value.
5. Turn the **MULTI JOG** dial (or press the remote control **▲** and **▼** buttons) to set the attenuation level.  
Range: 0dB (default) – –14dB (in 1dB increments)
7. After you complete the setting, press the **HOME/DISPLAY** button to return to the Home Screen.

#### NOTE

The analog output attenuation function setting is retained even when the unit is off.

### Viewing information about the media

You can view information about the media in the current device.

Follow these steps using the menu to access this information.

1. Press the **MENU [JOG]** button (or remote control **MENU** button) to open the **MENU** screen.
2. Open the **UTILITY** menu.
3. Select **INFORMATION**.

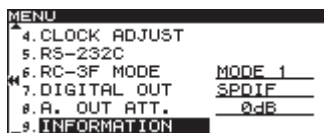

4. Press the **MULTI JOG** dial (or remote control **ENTER** button) to show information about the media, including its total capacity and open capacity, in the current device.

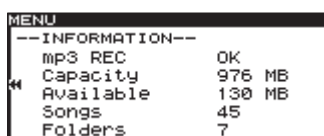

Example when the current device is USB/SD/CF

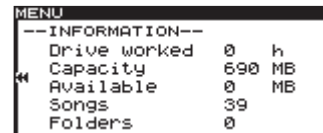

Example when the current device is CD

5. When you have finished viewing the information, press the **HOME/DISPLAY** button (or remote control **HOME/DISP** button) to return to the Home Screen.

### Restoring the factory settings

You can restore all the settings that are stored in the unit's backup memory to the settings they had when shipped from the factory.

Follow these steps using the menu to restore the settings.

#### NOTE

The factory settings cannot be restored if media is loaded in the current device. Change the current or remove the media from it and conduct the operation again.

1. Press the **MENU [JOG]** button (or remote control **MENU** button) to open the **MENU** screen.
2. Open the **UTILITY** menu.
3. Select **FACTORY PRESET**.

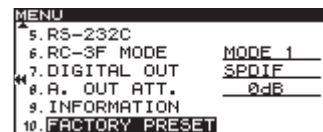

#### NOTE

The screen above is an example from an SS-CDR200 or SS-R200 unit. The SS-R100 does not have the **5. RS-232C** menu item.

4. Press the **MULTI JOG** dial (or remote control **ENTER** button).

A confirmation pop-up message appears.



5. Press the **MULTI JOG** dial (or remote control **ENTER** button) again to restore the unit settings to their factory defaults. A **COMPLETE** pop-up message appears briefly when resetting finishes.
6. When you have finished making the setting, press the **HOME/DISPLAY** button (or remote control **HOME/DISP** button) to return to the Home Screen.



### Checking the firmware versions used by the unit

You can check the system and drive firmware versions used by the unit (SS-CDR200 only).

1. Press the **MENU [JOG]** button (or remote control **MENU** button) to open the MENU screen.
2. Open the UTILITY menu screen.
3. Select the VERSION item.
4. Press the **MULTI JOG** dial (or remote control **ENTER** button).

The system and drive firmware versions used by the unit (SS-CDR200 only) are shown.

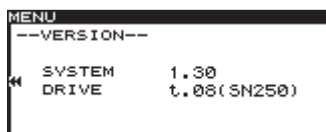

5. When you are done checking, press the **HOME/DISPLAY** button (or remote control **HOME/DISP** button) to return to the Home Screen.

# 13 – Operation using a computer keyboard

If you connect a keyboard with an IBM PC-compatible PS/2 interface or USB connector to the **KEYBOARD** connector or **USB** port, you can use it to operate this unit. Various types of control are possible, but using a keyboard is particularly efficient when inputting text.

## Setting the keyboard language

Set the keyboard language according to the one you have connected.

- 1 Press the **MENU [JOG] button** (or remote control **MENU button**) to open the **MENU** screen.
- 2 Open the **UTILITY** menu.
- 3 Select **KEYBOARD**.



- 4 Press the **MULTI JOG dial** or **▶▶ [LOCK] button** (or remote control **ENTER** or **▶** button) to move the cursor to the right and select the setting item.
- 5 According to the connected keyboard type, set it to **US** (English-language keyboard) or **JPN** (Japanese-language keyboard).  
**Options: US** (default value), **JPN**
- 6 When you have finished making the setting, press the **HOME/DISPLAY button** (or remote control **HOME/DISP button**) to return to the Home Screen.

### NOTE

The **KEYBOARD** setting is retained even after the power is turned OFF.

## Using a keyboard to input text

You can edit or enter a folder name, track name or CD-Text just as when typing text into a computer.

To edit the name of a file or folder, from the **FINDER** screen open its **FINDER MENU** and select **RENAME** to open the **RENAME** screen.

### To select the case:

As when using a computer, use the Shift and Caps Lock keys to change the case of characters input.

### To input text:

Use the number, letter and symbol keys for direct input.

### To move the cursor:

Use the **↑/↓/←/→** arrow keys.

### To delete a character:

**Delete key:** Deletes the character at the cursor location.

**Backspace key:** Deletes the character to the left of the cursor location.

### To insert a character:

Press the **Insert** key at the desired location.

### To edit a character:

Move the cursor and overwrite the character.

### CAUTION

- The following symbols and punctuation marks cannot be used in names.  
\\/:\*,? "<>|
- Japanese katakana cannot be input.

## Keyboard operation list

You can use the keyboard not only to enter text, but also for other operations such as controlling the transport and editing. The functions of keys on the keyboard are listed below.

### Transport operations

Keyboard key(s)	Operation
←	Same as the ◀◀ button
→	Same as the ▶▶ button
Space bar	Same as the <b>PLAY</b> button
Space bar	Same as the <b>READY</b> button
Ctrl + S	Same as the <b>STOP</b> button
Ctrl + R	Same as the <b>RECORD</b> button
Ctrl + F	Same as the ▶▶  button
Ctrl + B	Same as the  ◀◀ button
↑	Same as the ▶▶  button
↓	Same as the  ◀◀ button

# 13 – Operation using a computer keyboard

## MENU and FUNCTION screen operations

Keyboard key(s)	Operation
Esc	Cancel editing or title editing and return to the Home Screen
F1	Opens the <b>FUNCTION</b> screen
F2	Opens the <b>MENU</b> screen
F3	Opens the <b>EDIT</b> screen
F4	Opens the <b>FINDER</b> screen
F5	Turns repeat ON/OFF
F6	Turns A-B repeat ON/OFF
F7	Turns pitch control function ON/OFF
F8	Turns key control function ON/OFF
F9	Turns auto cue function ON/OFF
F10	Turns auto ready function ON/OFF
F11	Turns incremental playback function ON/OFF
F12	Same as the remote control <b>FLASH LOAD</b> button
Shift + F5	Set the file type
Shift + F6	Set the sampling frequency
Shift + F7	Set the bit rate
Shift + F8	Set the auto-recording function
Shift + F9	Set the sync recording function
Shift + F10	Set the sampling rate converter
Shift + F11	Set the compressor

Keyboard key(s)	Operation
Ctrl + F1	After completing flash loading, start flash start playback of track 1
Ctrl + F2	After completing flash loading, start flash start playback of track 2
Ctrl + F3	After completing flash loading, start flash start playback of track 3
Ctrl + F4	After completing flash loading, start flash start playback of track 4
Ctrl + F5	After completing flash loading, start flash start playback of track 5
Ctrl + F6	After completing flash loading, start flash start playback of track 6
Ctrl + F7	After completing flash loading, start flash start playback of track 7
Ctrl + F8	After completing flash loading, start flash start playback of track 8
Ctrl + F9	After completing flash loading, start flash start playback of track 9
Ctrl + F10	After completing flash loading, start flash start playback of track 10
Ctrl + F11	After completing flash loading, start flash start playback of track 11
Ctrl + F12	After completing flash loading, start flash start playback of track 12
Ctrl + E*	Same as the <b>EJECT</b> button
Ctrl + I	Select the input source
Ctrl + J	Turn jog playback mode ON
Ctrl + K	Set the skip time
Ctrl + L	Turns panel lock function ON/OFF
Ctrl + C	Turn the call function ON
Tab	Same as the front panel <b>DEVICE</b> and remote control <b>DEVICE SELECT</b> button
Caps Lock	Enable/disable capital letters
Back Space	Erase the character to the left of the cursor

Enter	Same as the front panel <b>MULTI JOG</b> dial and remote control <b>ENTER</b> button
Insert	Insert a character at the cursor position
Home	Same as the front panel <b>HOME/DISPLAY</b> button and remote control <b>HOME/DISP</b> button
Delete	Delete the character at the cursor position
↑	Same as turning the <b>MULTI JOG</b> dial left or pushing the remote control <b>^</b> button
↓	Same as turning the <b>MULTI JOG</b> dial left or pushing the remote control <b>v</b> button
←	Same as the front panel <b>&lt;&lt;</b> button and remote control <b>&lt;</b> button
→	Same as the front panel <b>&gt;&gt;</b> button and remote control <b>&gt;</b> button
Shift + ↑	Increases the display contrast
Shift + ↓	Decreases the display contrast
Ctrl + ↑	Increases the pitch level of the pitch control function
Ctrl + ↓	Decreases the pitch level of the pitch control function
Ctrl + ←	Increases the key level of the key control function
Ctrl + →	Decreases the key level of the key control function
Number keys	Number input

\*Ctrl + E only works with the SS-CDR200

### NOTE

To use the keyboard to edit, press the desired editing key when the **FINDER** screen is open.

Example of keyboard use

This example shows how to delete an item.

1. Press the **F4** key to open the **FINDER** screen.
2. Use the **↑/↓/←/→** keys to select the file or folder you want to delete.
3. Press the **F3** key to open the **EDIT** screen.
4. Use the **↑/↓** keys to select **DELETE**.
5. Press the **Enter** key to open an "EXECUTE?" confirmation pop-up.
6. Press the **Enter** again to confirm and execute the operation.

# 14 – Using control I/O (SS-CDR200/SS-R200 only)

## Using the RS-232C connector

Using the 9-pin, D-sub **CONTROL I/O RS-232C** connector, which is compliant with RS-232C standards, you can control the unit via this serial connection from a computer or other external device.

Use the menu to make settings related to communication.

- 1 Press the **MENU [JOG] button (or remote control MENU button)** to open the **MENU** screen.
- 2 Open the **UTILITY** menu.
- 3 Select **RS-232C**.

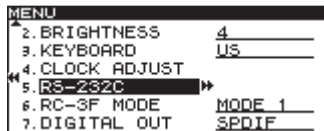

- 4 Press the **MULTI JOG dial or ►► [LOCK] button (or remote control ENTER or ► button)** to open the **RS-232C setting** screen.

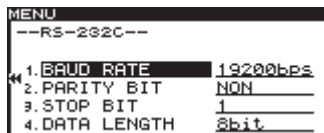

- 5 Set the items on the **RS-232C** screen.

### BAUD RATE

Set the baud rate (communication speed).

Options: 4800 bps, 9600 bps, 19200 bps (default value), 38400 bps

### PARITY BIT

Set the parity bit use.

Options: NON (none, default value), EVEN, ODD

### STOP BIT

Set the stop bit.

Options: 1 (default value), 2

### DATA LENGTH

Set the data length.

Options: 7, 8 (default value)

- 6 After setting each item, press the **HOME/DISPLAY button (or remote control HOME/DISP button)** to return to the **Home Screen**.

### NOTE

- RS-232C settings are retained even after the power is turned OFF.
- For details on the unit's RS-232C command protocol, please contact TASCAM customer support.

## Using the parallel connector

Using the **CONTROL I/O PARALLEL** connector, you can control this unit through serial connection with a TASCAM RC-SS20 or other external controller. The pin assignments are as follows.

Pin	Function	IN/OUT
1	GND	—
2	PLAY/Flash 1	In
3	STOP/Flash 2	In
4	RECORD/Flash 3	In
5	►► (Next)/Flash 4	In
6	◄◄ (Previous)/Flash 5	In
7	Flash Load	In
8	Fader Start	In
9	Flash Tally	Out
10	Ready Tally	Out
11	Record Tally	Out
12	Stop Tally	Out
13	Play Tally	Out
14	Remote Select*2	In
15	Ready/Flash 6	In
16	Call/Flash 7	In
17	Auto Cue/Flash 8	In
18	Auto Ready/Flash 9	In
19	Pitch/Flash 10	In
20	Flash Page*3	In
21	EOM Tally	Out
22	Device Select Tally 1*4	Out
23	—	—
24	Device Select Tally 2*4	Out
25	+5V*1	—

In: Active low external command reception (Functions when connected to GND for at least 30 msec usually and at least 1 sec when recording an MP3 file)

Out: Signal for transport status display by open drain (maximum voltage 50 V, maximum current 50 mA)

\*1 Maximum supplied current 100 mA.

\*2 Pin 14 (Remote Select)

When set to high, input pins with two functions shown above with a "/" (pins 2–6 and 15–19) use the first function, and can be used for ordinary parallel control.

When set to low, these input pins function as flash start keys.

\*3 Pin 20 (Flash Page)

When pin 14 (Remote Select) is set to low, the high/low setting of pin 20 determines the track assignments.

#14	#20	Flash start tracks
Low	High	1–10
Low	Low	11–20

## 14 – Using control I/O (SS-CDR200/SS-R200 only)

The following is an example of connecting for playback control of this unit using fader start/stop

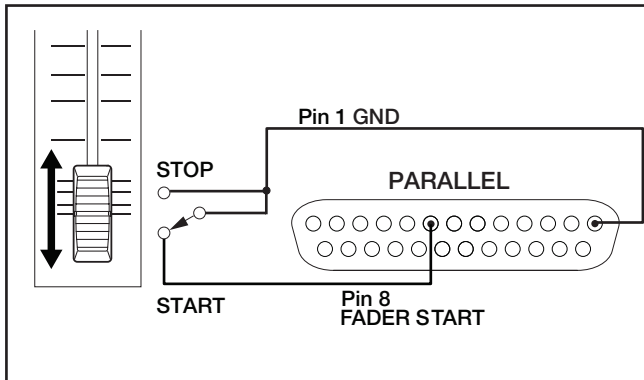

### \*4 Pin 22/24 (Device Select Tally 1/2)

Depending on the high/low settings of pins 22 and 24, the device assignment will be as follows.

#22	#24	Device assignment
Low	Low	USB
High	High	SD
High	Low	CF
Low	High	CD

# 15 – Message list

## Error messages

If one of the following error messages appears in a pop-up, press the **MULTI JOG** dial (or remote control **ENTER** button) to close the message. Then, resolve the issue. If you are still unable correct the problem, please contact the nearest TASCAM service center.

	1st line	2nd line	Meaning
1	- error -	DECODE	Failed to play MP3/WAV file.
2	- error -	REC STAND BY	Failed to prepare to begin recording.
3	- error -	CAPACITY	Recording stopped because of insufficient storage area on the media.
4	- error -	RECORD	Error occurred while recording.
5	- error -	INFO WRITING	An error occurred while writing data.
6	- error -	OVER FLOW	Recording buffer was insufficient while recording an MP3/WAV track.
7	- error -	Not Match DMA	Cannot record because the media does not meet the system requirements.
8	- error -	FLASH LOAD	Error occurred while loading flash start data.
9	- error -	DIN UNLOCK	Digital input is not locked.
10	- error -	DIN NotAudio	The input digital data is not audio.
11	- error -	FS UNMATCH	The sampling rate of the digital signal being input differs from the currently selected sampling rate.
12	- error -	EJECT	Failed to eject the CD (SS-CDR200 only)
13	- error -	MIX DISC	The disc has both MP3/WAV format files and audio CD format files mixed on it. (SS-CDR200 only)
14	- error -	MEMORY READ	Burn/Rip cannot be executed because media is not loaded in the selected device. (SS-CDR200 only).
15	- error -	TRACK	Playback is not possible because the file on the CD is in an unplayable format. (SS-CDR200 only)

## Warning messages

When an operation cannot be conducted, one of the following pop-up warning messages will appear on the display. After appearing for about two seconds, warning messages automatically disappear.

	1st line	2nd line	Meaning
1	- caution -	CAN'T UNDO	Undo is not possible because no undoable edit exists.
2	- caution -	MEDIA FULL	Recording is not possible because the media does not have enough open space.
3	- caution -	TRACK FULL	Recording is not possible because the maximum number of tracks has been reached.
4	- caution -	NoCallPoint	There is no call point.
5	- caution -	CAN'T REC	Recording is not possible due to system limitations.
6	- caution -	WriteProtect	The media is write-protected.
7	- caution -	NOT EXECUTE	Failed to execute the editing operation.
8	- caution -	CAN'T EDIT	Editing was not possible due to system limitations.
9	- caution -	CAN'T SELECT	Selection/execution was not possible due to system limitations.
10	- caution -	TRK PROTECT	Editing was not possible because the track was protected.
11	- caution -	NAME FULL	The maximum number of characters for the name (text field) has been reached.
12	- caution -	PROGRAM FULL	The track cannot be added because the maximum number of tracks in a program has been reached.
13	- caution -	PGM EMPTY	Playback is not possible because no tracks have been added to the program.
14	- caution -	NoSearchTime	Searching was not possible because the specified search time (search track) does not exist.
15	- caution -	UnmatchMedia	Recording is not possible because the media does not meet the system requirements.
16	- caution -	Dif Playlist	There is a discrepancy between the specified playlist and the media information.
17	- caution -	P.LIST FULL	The track cannot be added because the maximum number of tracks in a playlist has been reached.
18	- caution -	P.LIST EMPTY	Playback is not possible because no tracks have been added to the playlist.
19	- caution -	P.LIST ENTRY	You tried to edit a track that is in a playlist.

	1st line	2nd line	Meaning
20	- caution -	SURE TEXT	CD Text has been added, but you are trying to eject the disc without writing the TOC. (SS-CDR200 only)
21	- caution -	SAME NAME	An item with the same name already exists. (SS-CDR200 only)
22	Unapproved	FAT format	<p>The media has been formatted by something other than this unit, and this can cause the following problems.</p> <ul style="list-style-type: none"> <li>• When recording, writing data might not occur in time, resulting in errors.</li> <li>• MEDIA READING will take more time.</li> </ul> <p>We recommend using media that has been formatted by this unit.</p>

## Operation messages

As necessary, the following messages will appear in the time display area.

	1st line	Meaning
1	POWER ON	The system is starting up and initializing.
2	DEVICE ERROR	The device cannot be detected. Please contact TASCAM customer support.
3	NO MEDIA	Media is not loaded in the current device.
4	MONITOR	Now monitoring inputs.
5	MEDIA READING	Now reading from media.
6	MEDIA ERROR	Failed to read media.
7	UNKNOWN	The media is in a format other than FAT. Format the media with the unit in order to use them together.
8	INITIALIZING MEDIA	Creating data in order to use this media with the unit.
9	RECORD STAND BY	Now in recording standby.
10	INFORMATION WRITING	Now writing recording information.
11	FLASH LOADING	Now loading flash-start data.
12	Fs CHANGING	The system's sampling frequency is being changed to match that of the current track.

# 16 – Troubleshooting

If the unit is not functioning properly, please check the following items before calling for service. If you are still unable to resolve the problem please contact the retailer where you purchased the unit or TASCAM customer support.

## ■ Power does not turn on

Confirm that the power plug is inserted completely.

## ■ Media is not detected

- Confirm that the USB/SD/CF media is inserted completely.
- Stop playback or recording once.

## ■ Unit cannot be controlled from the front panel

Confirm that the panel lock function is not on.

## ■ Unable to playback a file

If it is a WAV file, confirm that it uses a sampling frequency (44.1 kHz or 48 kHz) and a bit rate (16/24-bit) that are supported by this unit. If it is an MP3 file, confirm that it uses a bit rate that is supported by this unit.

## ■ No sound

Confirm the connections with the monitoring system and check the volume of the amplifier.

## ■ Unable to record

- Confirm the connections.
- Adjust the recording level.
- If the media does not have enough open space, erase unneeded data to make more space or change the media.
- If the folder already contains a large number of entries (the total number of files, folders and other items), change the recording folder.

## ■ Changed settings are not saved

This unit backs-up settings whenever you change them. This backup could fail if you turn OFF the power while this data is being written, so do not turn OFF the power immediately after changing a setting.

## ■ I hear noise

Check if any connecting cable might have a bad connection.

## ■ When editing text, "Name Full" appears

Due to limitations of the system, a maximum of 255 characters (single-byte) can be used for items such as file and folder names. Since this limitation applies to the full path in the **FINDER** screen, the maximum name length for items inside a folder are reduced by the number of characters used by all the folders above it and any separator characters.



---

## Media and file formats

---

### Recording media

USB memory (512MB – 64GB)

SD card (512MB – 2GB)

SDHC card (4GB – 32GB)

CF card (512MB – 128GB, Type I only)

CD-R, CD-R-DA, CD-RW, CD-RW-DA (12cm discs only, High Speed CD-RW supported) (CDR200 model only)

### Recording and playback file formats

MP3: 44.1/48kHz, 64/128/192/256/320kbps

WAV: 44.1/48kHz, 16/24-bit (24-bit playback only)

CD-DA: 44.1kHz, 16-bit

### Number of channels

2-channel (stereo)

1-channel (mono)

---

## Inputs and outputs

---

### Analog audio inputs and outputs

#### ANALOG INPUTS (BALANCED)\*

##### (SS-CDR200/SS-R200 only)

Connector: XLR-3-31 (1: GND, 2: HOT, 3: COLD)

Input impedance: 22 k $\Omega$

Nominal input level: +4 dBu (1.23 Vrms)

Maximum input level: +20 dBu (7.75 Vrms)

Minimum input level: –6 dBu (0.39 Vrms) or more  
(minimum input level adjustable to nominal level)

#### ANALOG INPUTS (UNBALANCED)

Connector: RCA pin jack

Input impedance: 22 k $\Omega$

Nominal input level: –10 dBV (0.316 Vrms)

Maximum input level: +6 dBV (2.0 Vrms)

Minimum input level: –20 dBV (0.1 Vrms) or more  
(minimum input level adjustable to nominal level)

#### ANALOG OUTPUTS (BALANCED)\*

##### (SS-CDR200/SS-R200 only)

Connector: XLR-3-32 (1: GND, 2: HOT, 3: COLD)

Output impedance: 100  $\Omega$

Nominal output level: +4 dBu (1.23 Vrms)

Maximum output level: +20 dBu (7.75 Vrms)

#### ANALOG OUTPUTS (UNBALANCED)

Connector: RCA pin jack

Output impedance: 200  $\Omega$

Nominal output level: –10 dBV (0.316 Vrms)

Maximum output level: +6 dBV (2.0 Vrms)

\*If you want to change the maximum balanced input and output levels, please contact TASCAM customer support.

---

## Digital audio inputs and outputs

### DIGITAL IN JACK

Connector: RCA pin jack

Formats: IEC60958-3 (S/PDIF) and AES3-2003/IEC60958-4 (AES/EBU) detected automatically (AES3-2003/IEC60958-4 (AES/EBU) is a data format only; the physical format conforms to IEC60958-3 (S/PDIF))

Supported input sampling frequencies: 32–48 kHz

### DIGITAL OUT JACK

Connector: RCA pin jack

Formats: IEC60958-3 (S/PDIF) and AES3-2003/IEC60958-4 (AES/EBU) switchable (AES3-2003/IEC60958-4 (AES/EBU) is a data format only; the physical format conforms to IEC60958-3 (S/PDIF))

---

## Control inputs and outputs

### REMOTE JACK (for RC-3F and RC-20)

Connector: 2.5mm TRS jack

### USB PORT

Connector: USB A-type 4-pin

Protocol: USB 2.0 HIGH SPEED (480 Mbps)

### KEYBOARD

Connector: mini-DIN connector (PS/2)

### REMOTE IN (RC-SS2)

Connector: 3.5mm TRS jack

### RS-232C CONNECTOR (SS-CDR200/SS-R200 only)

Connector: 9-pin D-sub

### CONTROL I/O PARALLEL (SS-CDR200/SS-R200 only)

Connector: D-sub 25-pin

Maximum input voltage: +5.5 V

High level minimum input voltage: +3.75 V

Low level maximum input voltage: +1.25 V

Output format: open drain (withstand voltage 50 V, maximum 50 mA)

Low level maximum output voltage: 0.5 V

+5V power maximum supplied current: 100 mA

# 17 – Specifications

---

## Audio performance

---

### Frequency response

20 Hz – 20 kHz:  $\pm 0.5$  dB

### Distortion

0.005% or less

### S/N ratio

95 dB or more

### Dynamic range

95 dB

### Channel crosstalk

95 dB

Note: all ratings are for performance when recording according to JEITA CP-2150 standards

---

## Backup memory

---

The following settings are backed up even when the power is turned off.

- Pitch control ON/OFF
- Pitch step setting
- Key control ON/OFF
- Menu settings

(Playback area, playback mode, repeat playback setting, auto cue, auto ready, incremental playback, mono playback, EOM function, resume playback, power on playback, link playback, input source, input volume, recording file format, sync recording, auto track increment, pause mode, sampling rate converter, recording file name, compressor, dither, display and indicator brightness, keyboard type, RS-232C, footswitch, digital output)

---

## General

---

### Power

AC 100–240 V, 50–60 Hz

### Power consumption

#### SS-CDR200

100 V: 20 W

110–240 V: 23 W

#### SS-R200/SS-R100

100 V: 16 W

110–240 V: 20 W

### Dimensions (width × height × depth)

482.6 × 44.5 × 301 mm/19 × 1.75 × 11.85 in.

### Weight

#### SS-CDR200

3.7 kg/8.16 lbs

#### SS-R100/R200

3.4 kg/7.50 lbs

### Operating temperature range

5–35° C/41–95° F

## Dimensional drawings

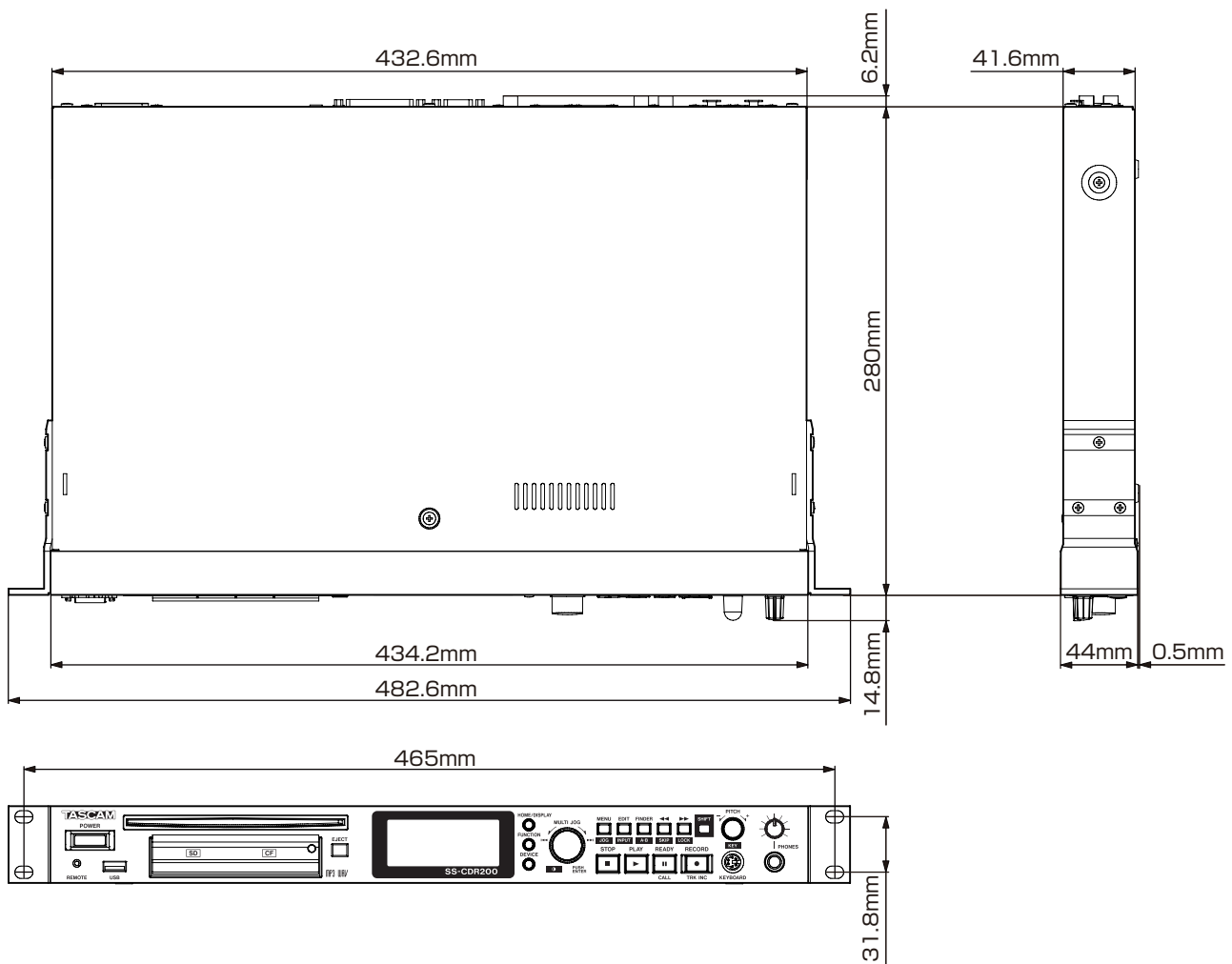

- Illustrations in this manual might differ in part from actual products.
- In order to improve the products, specifications and appearance could be changed without prior notice.

## WARRANTY

### < In the United States >

This warranty gives you specific legal rights and you may also have other rights which vary from state to state. This warranty is only valid within the country the unit was originally purchased.

### WHAT IS AND IS NOT COVERED

Except as specified below, this warranty covers all defects in materials and workmanship in this product. The following are not covered by the warranty:

1. Damage to or deterioration of the external cabinet.
2. Damages resulting from accident, misuse, abuse or neglect.
3. Damage resulting from failure to perform basic daily maintenance and/or calibration or otherwise resulting from failure to follow instructions contained in your owner's manual.
4. Damage occurring during shipment of the product. (Claims must be presented to the carrier)
5. Damage resulting from repair or attempted repair by anyone other than TEAC or an authorized TASCAM service station.
6. Damage resulting from causes other than product defects, including lack of technical skill, competence, or experience of the user.
7. Damage to any unit which has been altered or on which the serial number has been defaced, modified or is missing.

### WHO MAY ENFORCE THE WARRANTY

This warranty may be enforced only by the original purchaser.

### LENGTH OF WARRANTY

All parts except heads and disk drives are warranted for one (1) year from the date of original purchase. Heads and disk drives are warranted to ninety (90) days from date of original purchase. Labor is warranted for ninety (90) days from date of original purchase.

### WHAT WE WILL PAY FOR

We will pay all labor and material expenses for items covered by the warranty. Payment of shipping charges is discussed in the next section of this warranty.

### HOW YOU CAN GET WARRANTY SERVICE

Your unit must be serviced by an authorized TASCAM service station in the United States. (This warranty is not enforceable outside the U.S.) If you are unable to locate an authorized TASCAM service station in your area, please contact us. We either will refer you to an authorized service station or instruct you to return the unit to the factory. Whenever warranty service is required, you must present a copy of the original dated sales receipt from an Authorized TASCAM Dealer.

You must pay any shipping charges if it is necessary to ship the product to service. However, if the necessary repairs are covered by the warranty, we will pay return surface shipping charges to any destination within the United States.

### LIMITATION OF IMPLIED WARRANTIES

Any implied warranties, INCLUDING WARRANTIES OF MERCHANTABILITY AND FITNESS FOR A PARTICULAR PURPOSE, are limited in duration to the length of this warranty.

### EXCLUSION OF DAMAGES

TEAC's liability for any defective product is limited to repair or replacement of the product, at TEAC's option. TEAC shall not be liable for:

1. Damages based upon inconvenience, loss of use of the product, loss of time interrupted operation or commercial loss; or
2. Any other damages, whether incidental, consequential or otherwise.

Some states do not allow limitations on how long an implied warranty lasts and/or do not allow the exclusion or limitation of incidental or consequential damages, so the above limitations and exclusions may not apply to you.

### To locate an Authorized Service Center in Your Area

CALL 1-800-447-8322

### < Europe >

This product is subject to the legal warranty regulations of the country of purchase. In case of a defect or a problem, please contact the dealer where you bought the product.

Ce produit est sujet aux réglementations concernant la garantie légale dans le pays d'achat. En cas de défaut ou de problème, veuillez contacter le revendeur chez qui vous avez acheté le produit.

Dieses Gerät unterliegt den gesetzlichen Gewährleistungsbestimmungen des Landes, in dem es erworben wurde. Bitte wenden Sie sich im Gewährleistungsfall an den Händler, bei dem sie das Gerät erworben haben.

Questo apparecchio è conforme alle norme sulla garanzia vigenti nel rispettivo Paese in cui esso è stato acquistato. Si prega di rivolgersi al proprio commerciante, presso il quale è stato acquistato l'apparecchio, nel caso in cui si voglia richiedere una prestazione in garanzia.

Las condiciones de garantía de este aparato están sujetas a las disposiciones legales sobre garantía del país en el que ha sido adquirido. En caso de garantía, debe dirigirse al establecimiento donde adquirió el aparato.

### < In other countries/areas >

This warranty gives you specific legal rights, and you may also have other rights that vary by country, state or province.

If you have a warranty claim or request, please contact the dealer where you bought the product.

该保证书赋予了顾客特定的合法权利，并且因国家、州或省等地域的不同，顾客可能拥有其他权利。如需申请或要求保修，请与购买本产品的销售店进行联系。

If you require repair services for your TASCAM equipment, please contact the dealer where the product was purchased from or the TASCAM Distributor in your country. A list of TASCAM Distributors can be found on our website at: <http://teac-global.com/>

# TASCAM

## TEAC CORPORATION

Phone: +81-42-356-9143

1-47 Ochiai, Tama-shi, Tokyo 206-8530 Japan

<http://tascam.jp/>

## TEAC AMERICA, INC.

Phone: +1-323-726-0303

1834 Gage Road, Montebello, California 90640 USA

<http://tascam.com/>

## TEAC MEXICO, S.A. de C.V.

Phone: +52-55-5010-6000

Río Churubusco 364, Colonia Del Carmen, Delegación Coyoacán, CP 04100, México DF, México

<http://teacmexico.net/>

## TEAC UK LIMITED

Phone: +44-8451-302511

Meridien House, Ground Floor, 69 - 71, Clarendon Road, Watford, Hertfordshire, WD17 1DS, UK

<http://tascam.eu/>

## TEAC EUROPE GmbH

Phone: +49-611-71580

Bahnstrasse 12, 65205 Wiesbaden-Erbenheim, Germany

<http://tascam.eu/>

## TEAC SALES & TRADING(SHENZHEN) CO., LTD

Phone: +86-755-88311561~2

Room 817, Block A, Hailrun Complex, 6021 Shennan Blvd., Futian District, Shenzhen 518040, China

<http://tascam.cn/>

Printed in China

## WARRANTY

Model/Modèle/Modell  
Model/Modèle/Modell

SS-CDR200/SS-R100/SS-11100

Serial No./No. de Série/Seriennummer  
Numero di serie/Número de serie/序列号

Date of purchase/Date de l'achat/Datum des Kaufs  
Data dell'acquisto/Fecha de compra/购买日期

**TASCAM**

<http://teac-global.com/>

Owner's name/Nom du possesseur/Name des Eigentümers  
Nome del proprietario/Nombre del propietario/顾客姓名

Address/Adresse/Adresse  
Indirizzo/Dirección/顾客地址

Dealer's name/Nom du détaillant/Name des Händlers  
Nome del commerciante/Nombre del establecimiento/销售店名

Dealer's address/Adresse du détaillant/Adresse des Händlers  
Indirizzo del commerciante/Dirección del establecimiento/销售店地址

**Sample**